

6" Compact Fluorescent IC Rated Horizontal Commodity

Catalog #:	Type:
Notes:	

Product Specifications

Lamp:

- (1) 13/18/26W DTT/TRT 4 pin
- (1) 32W TRT 4 pin
- (2) 13/18/26W DTT 4 pin

Socket:

Complete with 1 or 2 positive latch, Thermoplastic socket for (2) horizontal mounted lamp.

Features:

- Heavy duty galvanized steel frame with die cast aluminum socket housing
- Designed for direct contact with insulation
- Large access junction box NRTL listed for through wiring
- (4) 1/2", (1) 3/4" and (4) Romex knock outs with pry-out slots
- Aluminum vertically mounted socket housing
- NRTL listed for damp location
- NRTL listed for through-branch circuit wiring.

Mounting:

16 gauge galvanized steel frame. Frame includes bar hangers with nails for wood joist. Adjustable 14" - 25" for precise placement. Bar hangers include T-bar notch for T-grid ceiling installations. Fixture fully assembled including prewired ballast and installed bar hangers for easy installation.

Ballast:

Advance Electronic 120/277V: 13/18/26/32/42W 4 PIN triple tube or quad lamp, NRTL listed, High power factor, Class P, sound rated A, type 1 outdoor, inherent Thermal Protection, no PCB's. Min start 0°F. Max THD 10%.

Advance Mark X Dimming Ballast:

- Dimming Range: 100% - 5% full range continuous dimming (T5/HO to 1%)
- Lamp Starting: programmed rapid start
- Programmed Start operation
- Minimum Lamp Starting Temperature: 10°C (50°F)
- Operating Voltage: 120V or 277V at 60Hz
- Total Harmonic Distortion (THD): less than 10%
- Minimizes risk of interference with infrared remote control systems and provides continuous flicker-free dimming

Lutron Hi-Lume Dimming:

- 18/26/32/42W 4 PIN triple tube or quad lamp
- Dimming Range: 100% to 5% measured relative light output (RLO)
- Lamp Starting: programmed rapid start
- Minimum Lamp Starting Temperature: 10°C (50°F)
- Ambient Temperature Operating Range: 10°C (50°F) to 60°C (140°F)
- Relative Humidity: maximum 90% non-condensing
- Operating Voltage: 120V or 277V at 60Hz
- Power Factor: greater than .95
- Total Harmonic Distortion (THD): less than 10%
- Maximum Ballast Case Temperature: 75°C (167°F)

Emergency Backup:

The compact fluorescent emergency ballast allows the same fixture to be used for both normal and emergency operation. In the event of a power failure, the ballast switches to emergency mode and operates (1) or (2) lamps for 90 minutes. The unit contains a battery, charger and inverter circuit in a single can. Ballast is factory prewired. Standard EM includes switch/charge indicator accessory kit.

Dimensions

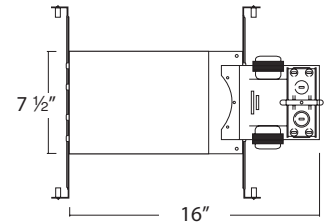
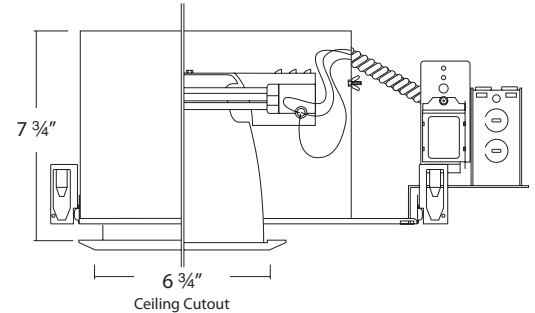

650 Lumen Emergency Backup Average Lumen Ratings			1300 Lumen Emergency Backup Average Lumen Ratings		
Lamp	1	2	Lamp	1	2
13W PL CF	350	400	13W PL CF	600	675
18W PL CF QUAD	350	550	18W PL CF QUAD	600	950
26W PL CF QUAD	425		26W PL CF QUAD	725	1200
32W PL CF QUAD 4-PIN	600		32W PL CF QUAD 4-PIN	1050	1250
42W PL CF QUAD 4-PIN	750		42W PL CF QUAD 4-PIN	1300	

Ordering Matrix ex: IF-13-11C-ADV-EM

IF	Series	Lamp/Wattage	Ballast/Voltage	Options
		13-11C (1) 13W DTT/TRT 18-11C (1) 18W DTT/TRT 26-11C (1) 26W DTT/TRT 32-11C (1) 32W TRT 13-21C (2) 13W DTT 18-21C (2) 18W DTT 26-21C (2) 26W DTT	E electronic 120/277V -ADV 120V advance dimming -ADV-27 277V advance dimming -LUT 120V lutron dimming -LUT-27 277V lutron dimming	-EM 650 lumen emergency backup -EM-13 1300 lumen emergency backup





*Note: Specifications and dimensions subject to change without notice.

¹EM2/EM2-13 for use with open reflector only.

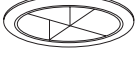
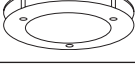

Catalog #:	Type:
Notes:	

6" Compact Fluorescent Horizontal Trims

Downlights

	CATALOG #	DESCRIPTION	LAMP	FINISH	TRIM OD
◆	 IC610	6" Horizontal Reflector	(1) 13/18/26W DTT/TRT (1) 32/42W TRT (2) 13/18/26W DTT 4 pin	C, C-SF, SD, SD-SF, W,	7 ¼"
◆	 IC611	6" Horizontal Clear Reflector W/ Baffle	(1) 13/18/26W DTT/TRT (1) 32/42W TRT (2) 13/18/26W DTT 4 pin	W, B	7 ¼"
◆	 IC614	6" Horizontal Cross Blade	(1) 13/18/26W DTT/TRT (1) 32/42W TRT (2) 13/18/26W DTT 4 pin	C	7 ¼"
	 ICH166	6" Horizontal Reflector W/ Drop Glass	(1) 13/18/26W DTT/TRT (1) 32/42W TRT (2) 13/18/26W DTT 4 pin	C-SF, SD-SF	7 ¼"
	 ICH161C	6" Horizontal Wall Wash Reflector	(1) 13/18/26W DTT/TRT (1) 32/42W TRT (2) 13/18/26W DTT 4 pin	C	7 ¼"

Wet Location Downlights

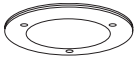
◆ ●	 IC612	6" Horizontal Reflector W/ Regressed Lens Specify Lens Type: -AB: albalite, -SB: sand blasted, -PR: prismatic, -FR: fresnel, -CR: clear tempered, -FSP: frosted spot	(1) 13/18/26W DTT/TRT (1) 32/42W TRT (2) 13/18/26W DTT 4 pin	C, C-SF, W	7 ¼"
◆ ●	 IC613	6" Horizontal Baffle W/ Regressed Lens Specify Lens Type: -AB: albalite, -SB: sand blasted, -PR: prismatic, -FR: fresnel, -CR: clear tempered, -FSP: frosted spot	(1) 13/18/26W DTT/TRT (1) 32/42W TRT (2) 13/18/26W DTT 4 pin	W, B	7 ¼"
●	 ICH164C-SF	6" Horizontal Reflector Surface Mount Glass	(1) 13/18/26W DTT/TRT (1) 32/42W TRT (2) 13/18/26W DTT 4 pin	C-SF	7 ¼"

Key Code:

● : Wet Location Listed ◆ : Optional metal trim ring. Specify MW (metal white), B (metal black), C (clear), MO (mocha), SN (satin nickel)
Special order trim ring Specify G (gold), AN (antique nickel), AC (antique copper), CAP (cappuccino)
Finish: W (white), B (black), SN (satin nickel), MO (mocha), PW (phenolic white). Reflector Finish: C (clear), W (white), B (black), G (gold), SD (semi diffuse)
*Note: Specifications and dimensions subject to change without notice.

2861. E La Palma Ave. • Anaheim, CA 92806 • Phone: 1.800.961.5321 • Fax: 1.800.961.5322 • www.intenselight.com



INTENSE
LIGHTING
Where Creativity and Performance Meet