

# IF5R

## 5" Compact Fluorescent Loose Socket Non-IC Remodel

<b>Catalog #:</b>	<b>Type:</b>
<b>Notes:</b>	

### Product Specifications

#### Description:

The IF5R recessed down light can be used for either commercial or residential remodel applications. Housing installs through existing cut out and is secured in place by four high tension springs. For use in non-insulated ceilings or must be kept at least 3" away from insulation.

#### Lamp:

- (1) 13W 4 Pin TRT
- (1) 18W 4 Pin TRT

#### Socket:

Universal GX24 4-Pin Socket

#### NB Loose Socket:

Free floating socket clips directly to trim for precise lamp placement, optimal performance and uniformity from fixture to fixture.

#### Junction Box:

Galvanized steel junction box with 1/2" and romex wiring knockouts, with removable access plates for easy installation.

#### Installation:

Four high tension springs secure housing into ceiling with up to 5/8" thickness.

#### Ballast:

Advance Electronic 120/277V: 13/18/26W 4 PIN triple tube or quad lamp, NRTL listed, High power factor, Class P, sound rated A, type 1 outdoor, inherent Thermal Protection, no PCB's. Min start 0°F. Max THD 10%.

#### Advance Mark X Dimming Ballast:

- Dimming Range: 100% - 5% full range continuous dimming (T5/HO to 1%)
- Lamp Starting: programmed rapid start
- Programmed Start operation
- Minimum Lamp Starting Temperature: 10°C (50°F)
- Operating Voltage: 120V or 277V at 60Hz
- Total Harmonic Distortion (THD): less than 10%
- Minimizes risk of interference with infrared remote control systems and provides continuous flicker-free dimming

#### Lutron Hi-Lume Dimming:

- Dimming Range: 100% to 5% measured relative light output (RLO)
- Lamp Starting: programmed rapid start
- Minimum Lamp Starting Temperature: 10°C (50°F)
- Ambient Temperature Operating Range: 10°C (50°F) to 60°C (140°F)
- Relative Humidity: maximum 90% non-condensing
- Operating Voltage: 120V or 277V at 60Hz
- Power Factor: greater than .95
- Total Harmonic Distortion (THD): less than 10%
- Maximum Ballast Case Temperature: 75°C (167°F)

#### Emergency Backup:

The compact fluorescent emergency ballast allows the same fixture to be used for both normal and emergency operation. In the event of a power failure, the ballast switches to emergency mode and operates (1) or (2) lamps for 90 minutes. The unit contains a battery, charger and inverter circuit in a single can. Ballast is factory prewired. Standard EM includes switch/charge indicator accessory kits.

#### Labels:

- NRTL listed for through-branch wiring and damp locations.
- NRTL listed to US and Canadian safety standards.

### Dimensions

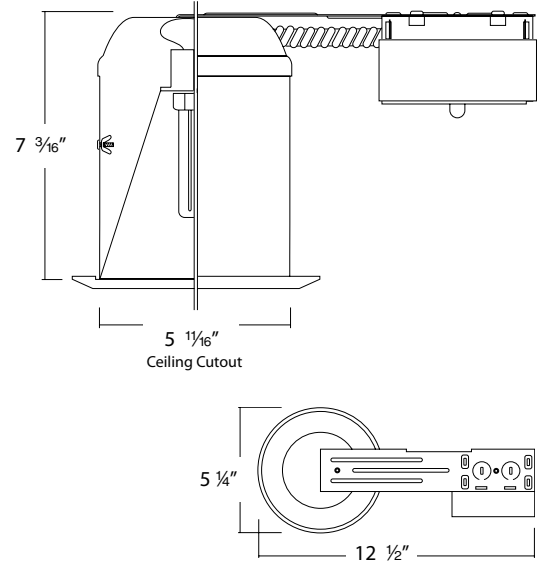

650 Lumen Emergency Backup Average Lumen Ratings			1300 Lumen Emergency Backup Average Lumen Ratings		
Lamp	1	2	Lamp	1	2
13W PL CF	350	400	13W PL CF	600	675
18W PL CF QUAD	350	550	18W PL CF QUAD	600	950
26W PL CF QUAD	425		26W PL CF QUAD	725	1200
32W PL CF QUAD 4-PIN	600		32W PL CF QUAD 4-PIN	1050	1250
42W PL CF QUAD 4-PIN	750		42W PL CF QUAD 4-PIN	1300	

### Ordering Matrix ex: IF5R13-ADV-27-EM-13-NB

#### IF5R

<b>Series</b>	<b>Lamp/Wattage</b>	<b>Ballast/Voltage</b>	<b>Options</b>	<b>-NB</b>
	13 (1) 13W TRT 18 (1) 18W TRT	E electronic 120/277V -ADV 120V advance dimming -ADV-27 277V advance dimming -LUT 120V lutron dimming -LUT-27 277V lutron dimming	-EM Emergency battery back up with remote test switch 600 lumen -EM-13 Emergency battery back up with remote test switch 1300 lumen	

\*Note: Specifications and dimensions subject to change without notice.





2861. E La Palma Ave. • Anaheim, CA 92806 • Phone: 1.800.961.5321 • Fax: 1.800.961.5322 • www.intenselighting.com





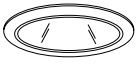

<b>Catalog #:</b>	<b>Type:</b>
<b>Notes:</b>	

## 5" Compact Fluorescent Loose Socket Trims

### Loose Socket Trims

	CATALOG #	DESCRIPTION	LAMP	FINISHES	TRIM OD
◆	 <b>IC59</b>	5" Cone Reflector	(1) 13/18W TRT	W, B, C	6 3/4"
◆	 <b>IC52</b>	5" Clear Reflector With Baffle	(1) 13/18W TRT	W, B	6 3/4"
	 <b>ICR530</b>	5" Full Reflector Baffle Trim	(1) 13/18W TRT	W, B	6 3/4"
	 <b>ICR535W</b>	5" Full Reflector Trim	(1) 13/18W TRT	W, B	6 3/4"

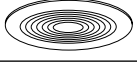
### Wet Location Downlights

●	 <b>IC56</b>	5" Round Opal Lens Shower Trim	(1) 13/18W TRT	W, B, SN, MO	6 3/4"
●	 <b>ICS52</b>	5" Shower With Albalite	(1) 13/18W TRT	W, B, SN, MO	6 3/4"
●	 <b>ICS53</b>	5" Shower With Fresnel	(1) 13/18W TRT	W, B, SN, MO	6 3/4"
●	 <b>ICS56</b>	5" Shower With Drop Opal Lens	(1) 13/18W TRT	W, B, SN, MO	6 3/4"
●	 <b>ICS57</b>	5" Shower With Frosted Spot Lens	(1) 13/18W TRT	W, B, SN, MO	6 3/4"

**Key Code:**

● : Wet Location Listed ◆ : Optional metal trim ring. Specify MW (metal white), B (metal black), C (clear), MO (mocha), SN (satin nickel)

Special order trim ring Specify G (gold), AN (antique nickel), AC (antique copper), CAP (cappuccino)

Finish: W (white), B (black), SN (satin nickel), MO (mocha), PW (phenolic white). Reflector Finish: C (clear), W (white), B (black), G (gold), SD (semi diffuse)

\*Note: Specifications and dimensions subject to change without notice.

