

# IF6

## 6" Compact Fluorescent Non-IC New Construction

<b>Catalog #:</b>	<b>Type:</b>
<b>Notes:</b>	

### Product Specifications

#### Description:

The IF6 recessed down light can be used for either commercial or residential new construction applications. For use in non-insulated ceilings. Must be kept at least 3" away from insulation.

#### Lamp:

- (1) 13W 4 Pin DTT or TRT
- (1) 18W 4 Pin DTT or TRT
- (1) 26W 4 Pin TRT

#### Socket:

Universal GX24 4-Pin Socket

#### Socket Plate:

Adjustable socket plate adjusts and locks in position without tools for multiple lamp and trim types.

#### NB Loose Socket Option:

Free floating socket clips directly to trim for precise lamp placement, optimal performance and uniformity from fixture to fixture. (Specify -NB for loose socket option)

#### Junction Box:

Galvanized steel junction box with 1/2" and romex wiring knockouts, with removable access plates for easy installation.

#### Installation:

Includes adjustable hanger bars (14"-25") with integral nail. Bar hangers can be repositioned 90° without tools. Barhangers can be locked into place with locking screws.

#### Ballast:

Advance Electronic 120/277V: 13/18/26W 4 PIN triple tube or quad lamp, NRTL listed, High power factor, Class P, sound rated A, type 1 outdoor, inherent Thermal Protection, no PCB's. Min start 0°F. Max THD 10%.

#### Advance Mark X Dimming Ballast:

- Dimming Range: 100% - 5% full range continuous dimming (T5/HO to 1%)
- Lamp Starting: programmed rapid start
- Programmed Start operation
- Minimum Lamp Starting Temperature: 10°C (50°F)
- Operating Voltage: 120V or 277V at 60Hz
- Total Harmonic Distortion (THD): less than 10%
- Minimizes risk of interference with infrared remote control systems and provides continuous flicker-free dimming

#### Lutron Hi-Lume Dimming:

- Dimming Range: 100% to 5% measured relative light output (RLO)
- Lamp Starting: programmed rapid start
- Minimum Lamp Starting Temperature: 10°C (50°F)
- Ambient Temperature Operating Range: 10°C (50°F) to 60°C (140°F)
- Relative Humidity: maximum 90% non-condensing
- Operating Voltage: 120V or 277V at 60Hz
- Power Factor: greater than .95
- Total Harmonic Distortion (THD): less than 10%
- Maximum Ballast Case Temperature: 75°C (167°F)

#### Emergency Backup:

The compact fluorescent emergency ballast allows the same fixture to be used for both normal and emergency operation. In the event of a power failure, the ballast switches to emergency mode and operates (1) or (2) lamps for 90 minutes. The unit contains a battery, charger and inverter circuit in a single can. Ballast is factory prewired. Standard EM includes switch/charge indicator accessory kits.

#### Labels:

- NRTL listed for through-branch wiring and damp locations.
- NRTL listed to US and Canadian safety standards.

### Dimensions

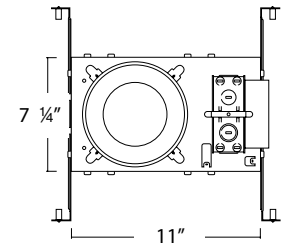
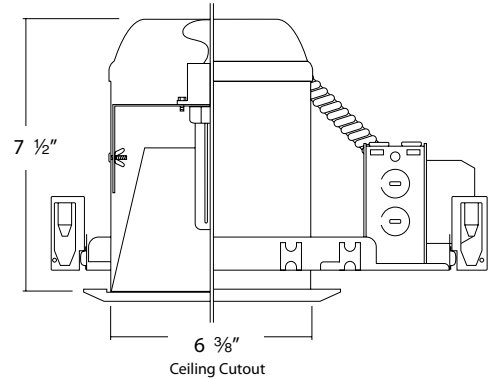

650 Lumen Emergency Backup Average Lumen Ratings			1300 Lumen Emergency Backup Average Lumen Ratings		
Lamp	1	2	Lamp	1	2
13W PL CF	350	400	13W PL CF	600	675
18W PL CF QUAD	350	550	18W PL CF QUAD	600	950
26W PL CF QUAD	425		26W PL CF QUAD	725	1200
32W PL CF QUAD 4-PIN	600		32W PL CF QUAD 4-PIN	1050	1250
42W PL CF QUAD 4-PIN	750		42W PL CF QUAD 4-PIN	1300	

### Ordering Matrix

IF6			
Series	Lamp/Wattage	Ballast/Voltage	Options
13	(1) 13W DTT/TRT	E electronic 120/277V	-NB loose socket
18	(1) 18W DTT/TRT	-ADV 120V advance dimming	-EM Emergency battery back up with remote test switch 600 lumen
26	(1) 26W TRT	-ADV-27 277V advance dimming	-EM-13 Emergency battery back up with remote test switch 1300 lumen
		-LUT 120V lutron dimming	
		-LUT-27 277V lutron dimming	

\*Note: Specifications and dimensions subject to change without notice.





2861. E La Palma Ave. • Anaheim, CA 92806 • Phone: 1.800.961.5321 • Fax: 1.800.961.5322 • www.intenselighting.com



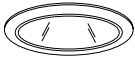

<b>Catalog #:</b>	<b>Type:</b>
<b>Notes:</b>	

## 6" Compact Fluorescent Trims





### Fixed Socket Trims

	CATALOG #	DESCRIPTION	LAMP	FINISHES	TRIM OD
◆	 ICR9	6" Reflector For (1) Lamp	(1) 13/18/26W Triple Tube	W, C, SD	7 ¼"
◆	 ICB5	6" Clear Reflector W/ Baffle	(1) 13/18/26W Triple Tube	W, B	7 ¼"
	 ICFRW9	6" Clear Reflector Wall Wash	(1) 13/18/26W Triple Tube	CW	7 ¼"
	 ICR12	6" Clear Reflector W/ Drop Glass	(1) 13/18/26W Triple Tube	C, SD	7 ¼"

### Loose Socket Trims For Use With -NB Housing

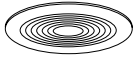
	 ICR30	6" Full Reflector Baffle Trim	(1) 13/18/26W Triple Tube	W	7 ¼"
	 ICR35	6" Full Reflector Trim	(1) 13/18/26W Triple Tube	W	7 ¼"

### Fixed Socket Shower Trims

●	 ICFS3	6" Shower With Fresnel Lens	(1) 13/18/26W Triple Tube	W, PW, SN, MO	7 ¼"
●	 ICFS2	6" Shower With Albalite Lens	(1) 13/18/26W Triple Tube	W, PW, SN, MO	7 ¼"
●	 ICFS5	6" Shower With Sand Blasted Lens	(1) 13/18/26W Triple Tube	W, PW, SN, MO	7 ¼"
●	 ICFS6	6" Shower With Drop Opal Lens	(1) 13/18/26W Triple Tube	W, PW	7 ¼"
●	 ICFS7	6" Shower With Frosted Spot Lens	(1) 13/18/26W Triple Tube	W, PW, SN, MO	7 ¼"

#### Key Code:

● : Wet Location Listed ◆ : Optional metal trim ring. Specify MW (metal white), B (metal black), C (clear), MO (mocha), SN (satin nickel)  
 Special order trim ring Specify G (gold), AN (antique nickel), AC (antique copper), CAP (cappuccino)  
 Finish: W (white), B (black), SN (satin nickel), MO (mocha), PW (phenolic white). Reflector Finish: C (clear), W (white), B (black), G (gold), SD (semi diffuse)  
 \*Note: Specifications and dimensions subject to change without notice.

2861. E La Palma Ave. • Anaheim, CA 92806 • Phone: 1.800.961.5321 • Fax: 1.800.961.5322 • [www.intenselightning.com](http://www.intenselightning.com)

