

# ITH637

## HID Metal Halide

### PAR38MH 70W Stage III Theatrical Fixture Track Head

<b>Catalog #:</b>	<b>Type:</b>
<b>Notes:</b>	

#### Product Specifications

**Lamp:**

PAR38MH 70W

**Socket:**

E26 Medium Base

**Features:**

- Light weight, strong construction
- Clean style
- Adjustable for precision aiming
- One or two circuit track capability
- Compatible with Intense Lighting's Professional Series track
- Electronic ballast

**Track Compatibility:**

Single/two circuit positive contact is present to "down" position at factory, but may be raised to the higher position to install onto the second circuit.

**Electronic Ballast:**

High Power Factor.  
 Input:  
 .27A @ 70W  
 Open Circuit Voltage 300V max.  
 Sound Rated A  
 Max. case temp +80°C  
 Ignition Voltage 4.0KV max.  
 THD < 5%  
 PF > 98%  
 Outdoor Type 1

**Professional Series Option:**

Track fixture is compatible with Intense Two Circuit / Two Neutral Professional Track series. Track adapter is factory installed on fixture. Must specify -27 for 277V.

Two Circuit / Two Neutral 120V. The independent neutrals guarantee that the two circuits are completely isolated. Independent neutrals also offer twice the power handling capacity of ordinary common neutral track.

Two Circuit / Two Neutral 277V  
 The Intense Professional Series 2-cct/2-neutral 277V track system is well suited for larger retail and institutional applications where a number of metal halide or fluorescent fixtures are used. The 277V system offers twice the capacity of ordinary 120V track allowing for substantially longer runs with more fixtures between feed points. This translates into enhanced aesthetics and reduced installation costs.

**Listing:**  
 NRTL listed for dry locations

#### Dimensions

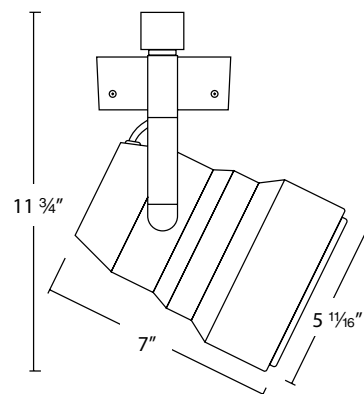

#### Ordering Matrix

### ITH637

Series	Finish	Options
	<b>W</b> white <b>B</b> black <b>SN</b> satin nickel	<b>-PS</b> 120V pro series <b>-PS-27</b> 277V pro series

\*Note: Specifications and dimensions subject to change without notice.

