

GD6AS / ISA600

6" Gravity LED Square Adjustable

JOB NAME		CATALOG NUMBER	
NOTES		TYPE	

ELECTRICAL DATA: (Data Based On 3000K/82CRI Configuration)

LED Light Engine	Nominal Delivered Lumens *	System Wattage **	Efficacy	LED Light Engine	Nominal Delivered Lumens *	System Wattage **	Efficacy
L1	1000lm	10W	100 lm/W	L7	4000lm	36W	111 lm/W
L2	1500lm	12W	125 lm/W	L8	4500lm	43W	105 lm/W
L3	2000lm	14W	143 lm/W	L9	5000lm	49W	102 lm/W
L4	2500lm	18W	139 lm/W	L10	6000lm	50W	120 lm/W
L5	3000lm	23W	130 lm/W	L11	7000lm	60W	117 lm/W
L6	3500lm	30W	117 lm/W				

* Delivered lumen output will vary depending on CCT, CRI, optic and reflector finish. | ** System Wattage include driver and LED Module consumption.

LED LIGHT ENGINE

- 82/92 CRI, 2700K, 3000K, 3500K or 4000K
- 2 Step MacAdam (2 SDCM)
- Rated life of >50,000 hours L70 based on LED testing per LM-80-08 and projected values using IESNA TM21-11

DIMMING

- Forward/Reverse Phase Dimming 5% (120V only)
- 0-10V Dimming 1%
- eldoLED 0-10V 0.1% or 1%
- Lutron® LDE1 Hi-Lume 1% EcoSystem LED driver with Soft-on, Fade-to-Black dimming technology
- DMX512 RDM 0.1%

OPTICS

- 14° Narrow Spot, 20° Spot, 30° Narrow Flood, 40° Flood, 50° Wide Flood and 60° Very Wide Flood
- Optics and filter media are field interchangeable

ELECTRICAL SYSTEM

- Dedicated voltage options of 120V, 277V or 347V. Must be specified in catalog code
- 347V available with -D101 in L1 to L7 only, consult factory for lead times
- Multiple dimming drivers available
- This product complies with IEEE C62.41 for surge endurance up to 2.5KV. Additional surge protection recommended. Damage from power surge is not covered by warranty.

FRAME CONSTRUCTION

Constructed from 16 and 18 gauge heavy duty powder coated cold rolled steel frame with a large access junction box. ETL listed for through wiring. LED light engine and driver are accessible from above or below ceiling. 40° vertical and 362° horizontal adjustment with locking.

REFLECTOR

Specification grade reflector with 1.5mm thickness. Reflector available in black, clear, haze or white finish. Consult factory for other colors. Architectural, discrete polished self flange standard. Optional painted white flange is available.

INSTALLATION

The luminaire is type Non-IC. Insulation must be kept at a minimum of 3" away from fixture. Accommodates up to 1 1/4" ceiling thickness. Universal mounting brackets included. Compatible with C-channel, flat bar, wood joist bar hanger and EMT. Bar hangers must be ordered separately. C-channel is recommended for T-bar ceilings. Max. ambient temperature: 95°F (35°C).

EMERGENCY BACKUP

Remote test switch included. External battery operates LED load of up to 7W at a minimum of 400 lumens for 90 minutes (EM7), or 20W at a minimum of 1200 lumens for 90 minutes (EM20).

ACCESSORIES

Luminaire accepts (1) media filter and (1) hex cell louver.

LISTING / WARRANTY

- ETL Listed to US and Canadian standards for damp locations
- 5-Year Intense LED Limited Warranty

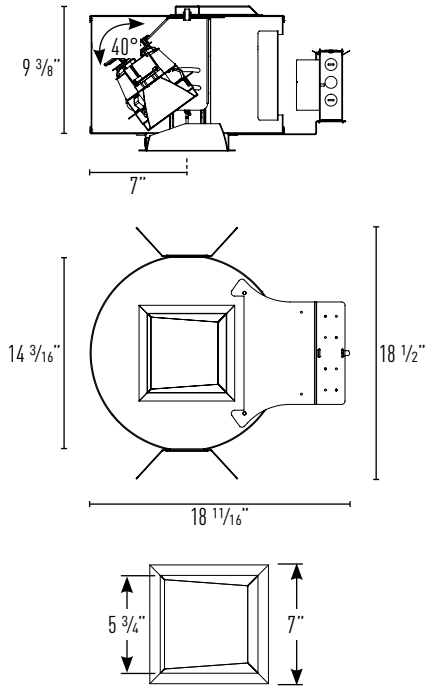

Ceiling Cut Out: 6 1/2" x 6 1/2"
Maximum Ceiling Thickness: 1 1/4"

Housing Part Number: (Example: GD6ASL327-DIM-NS)

Housing	Wattage		CCT / CRI	Dimming	Voltage	Optic	Options			
GD6AS	L1 ¹	(10W)	L7	(36W)	27	(2700K/82CRI)	-DIM ² (Phase Dimming 5%)	blank (120V)	-NS ⁴ (14° Narrow Spot)	EM7 (7W Emergency Backup w/ Remote Test Switch)
	L2 ¹	(12W)	L8	(43W)	279	(2700K/92 CRI)	-D101 (0-10V Dimming 1%)	27 (277V)	-SP (20° Spot)	IOTA part #ILB-CP07-A
	L3	(14W)	L9	(49W)	30	(3000K/82 CRI)	-ED10V1 ³ (eldoLED 0-10V 1%)	34 ⁹ (347V)	-NF (30° Narrow Flood)	EM20 ¹⁰ (20W Emergency Backup w/ Remote Test Switch)
	L4	(18W)	L10	(50W)	309	(3000K/92 CRI)	-ED10V01 ³ (eldoLED 0-10V 0.1%)		-FL (40° Flood)	IOTA ILB-CP20-HE-A
	L5	(23W)	L11	(60W)	35	(3500K/82 CRI)	-LUT ⁴ (Lutron® LDE1 EcoSystem 1%)		-WF ⁷ (50° Wide Flood)	
	L6	(30W)			359	(3500K/92 CRI)	-DMXR ⁵ (DMX512 RDM 0.1%)		-VF ⁸ (60° Very Wide Flood)	
					40	(4000K/82 CRI)				
				409	(4000K/92 CRI)					

Reflector Part Number: (Example: ISA600HZ-SF)

Reflector	Reflector Finish
ISA600	HZ-SF (Haze, Self-Flanged)
	HZ-SFW (Haze, Self-Flanged White)
	W-SF (White, Self-Flanged)
	C-SF (Clear, Self-Flanged)
	C-SFW (Clear, Self-Flanged White)
	B-SF ¹¹ (Black, Self-Flanged)

Accessories
PFL2-111 (Linear Spread)
PFL4-111 (Soft Focus Lens)
PFLMB-111 (Black Hex Louver)
I100 (C-Channel Bar Hangers)
I200 (Flat Bar Hangers)
I400 (Wood Joist Bar Hangers)

Notes:

- L1 & L2 only available with -D101
- Available in 120V only and Not available with L14
- eldoLED dimming available with L3-L11
- Lutron® dimming available with L3-L8
- DMX512 RDM available with L4-L11
- 14° Optic (NS) available on L1-L9 only
- 50° for L1-L9 only accepts (1) media filter
- 60° Optic (VF) available on L10-L11 only. Accepts only one filter media accessory.
- 347V available with -D101 in L1 to L7 only, consult factory for lead times.
- EM20 only available for L5 to L11
- Consult Factory For Lead Times

GRAVITY ADJUSTABLE L/M-049-24-P-6

INTENSE LIGHTING | 3340 E La Palma Ave, Anaheim, CA 92806 | tel 714 630-9877 | fax 714 630-9883

For Intense Lighting's limited product warranty, go to www.intenselighting.com. For a printed copy of the warranty, you may call 800 961-5321.

© 2024 Intense Lighting, LLC. All rights reserved. Note: This document is subject to change without notice.



JOB NAME		CATALOG NUMBER	
NOTES		TYPE	

GD6ASL3 ISA600HZ

Report #: ILL20200129-2.001 (14)
 ILL20200129-10.001 (20)
 ILL20200130-6.001 (30)
 ILL20200130-12.001 (40)
 ILL20200131-6.001 (50)

CCT MULTIPLIERS:

	82 CRI	92 CRI
2700K	(x 0.95)	(x 0.79)
3000K	(x 1.00)	(x 0.82)
3500K	(x 1.02)	(x 0.85)
4000K	(x 1.03)	(x 0.88)

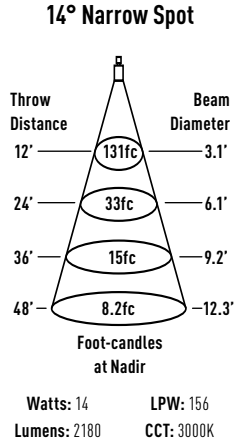

Intensity	
Degree	CBCP
0°	18816
5°	14614
15°	1853
25°	810
35°	65
45°	31

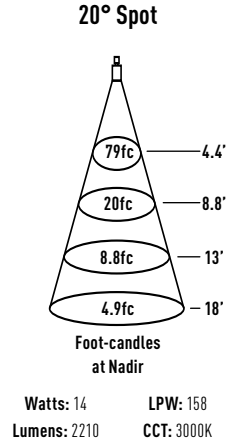

Intensity	
Degree	CBCP
0°	11366
5°	8538
15°	2829
25°	852
35°	51
45°	33

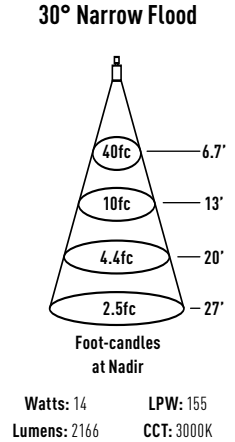

Intensity	
Degree	CBCP
0°	5749
5°	5471
15°	3033
25°	1251
35°	84
45°	27

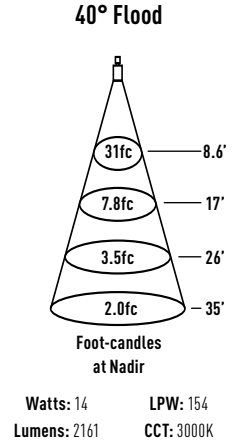

Intensity	
Degree	CBCP
0°	4482
5°	4315
15°	3122
25°	1373
35°	104
45°	36

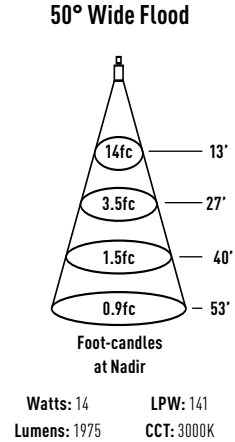

Intensity	
Degree	CBCP
0°	2011
5°	1974
15°	1700
25°	1249
35°	640
45°	217

APPLICATION DATA:

Illuminated width & length are based upon point at which illuminance falls to 50% of center illuminance. Recommended spacing is based upon uniform illuminance aiming angle is the angle between the lamp axis and the perpendicular to the illuminated plane.

W and **L** are the outer points where the candle power drops to 50% of maximum. **FC** are the initial foot candles at the center of the beam.

- W** Beam width
- L** Beam length
- C** Distance to center of beam
- D** Distance
- FC** Footcandles

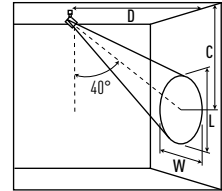
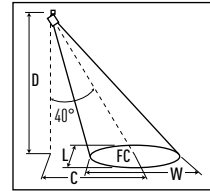
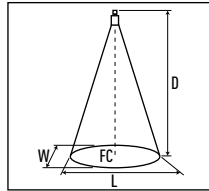

	D	FC	W	L	D	C	FC	W	L	D	C	FC	W	L
GD6ASL330-14 14° Narrow Spot	12'	130.67	3.07	3.15	12'	10.07	58.74	5.44	4.01	6'	7.15	138.81	2.39	3.91
	24'	32.67	6.14	6.31	24'	20.14	14.68	10.88	8.01	12'	14.3	34.7	4.77	7.83
	36'	14.52	9.2	9.46	36'	30.21	6.53	16.32	12.02	18'	21.45	15.42	7.16	11.74
	48'	8.17	12.27	12.62	48'	40.28	3.67	21.76	16.02	24'	28.6	8.68	9.55	15.65
GD6ASL330-20 20° Spot	12'	78.93	4.39	4.39	12'	10.07	35.48	7.67	5.74	6'	7.15	83.85	3.42	5.58
	24'	19.73	8.79	8.79	24'	20.14	8.87	15.34	11.47	12'	14.3	20.96	6.84	11.17
	36'	8.77	13.18	13.18	36'	30.21	3.94	23.01	17.21	18'	21.45	9.32	10.25	16.75
	48'	4.93	17.58	17.58	48'	40.28	2.22	30.68	22.94	24'	28.6	5.24	13.67	22.33
GD6ASL330-30 30° Narrow Flood	12'	39.93	6.69	6.72	12'	10.07	17.95	12.13	8.73	6'	7.15	42.41	5.20	9.16
	24'	9.98	13.38	13.45	24'	20.14	4.49	24.25	17.47	12'	14.3	10.60	10.41	18.31
	36'	4.44	20.07	20.17	36'	30.21	1.99	36.38	26.20	18'	21.45	4.71	15.61	27.47
	48'	2.50	26.76	26.89	48'	40.28	1.12	48.51	34.93	24'	28.6	2.65	20.82	36.63
GD6ASL330-40 40° Flood	12'	31.13	8.61	8.68	12'	10.07	13.99	16.28	11.24	6'	7.15	33.07	6.70	12.89
	24'	7.78	17.23	17.35	24'	20.14	3.50	32.57	22.49	12'	14.3	8.27	13.40	25.78
	36'	3.46	25.84	26.03	36'	30.21	1.55	48.85	33.73	18'	21.45	3.67	20.10	38.68
	48'	1.95	34.45	34.70	48'	40.28	0.87	65.13	44.97	24'	28.6	2.07	26.80	51.57
GD6ASL330-50 50° Wide Flood	12'	13.96	13.34	13.32	12'	10.07	6.28	28.97	17.41	6'	7.15	14.83	10.37	28.64
	24'	3.49	26.67	26.63	24'	20.14	1.57	57.95	34.82	12'	14.30	3.71	20.75	57.28
	36'	1.55	40.01	39.95	36'	30.21	0.70	86.92	52.23	18'	21.45	1.65	31.12	85.91
	48'	0.87	53.35	53.27	48'	40.28	0.39	115.90	69.64	24'	28.6	0.93	41.50	114.55

JOB NAME		CATALOG NUMBER	
NOTES		TYPE	

GD6ASL4 ISA600HZ

Report #: ILL20200129-2.001 (14)
ILL20200129-10.001 (20)
ILL20200130-6.001 (30)
ILL20200130-12.001 (40)
ILL20200131-6.001 (50)

CCT MULTIPLIERS:

	82 CRI	92 CRI
2700K	(x 0.95)	(x 0.79)
3000K	(x 1.00)	(x 0.82)
3500K	(x 1.02)	(x 0.85)
4000K	(x 1.03)	(x 0.88)

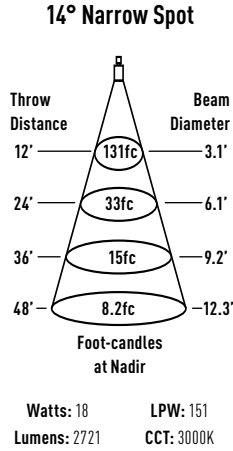

Intensity	
Degree	CBCP
0°	18816
5°	14614
15°	1853
25°	810
35°	65
45°	31

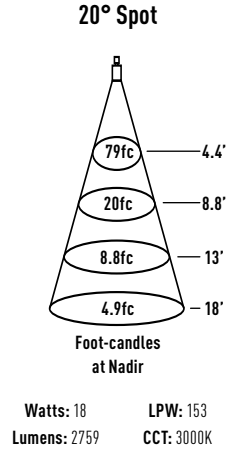

Intensity	
Degree	CBCP
0°	11366
5°	8538
15°	2829
25°	852
35°	51
45°	33

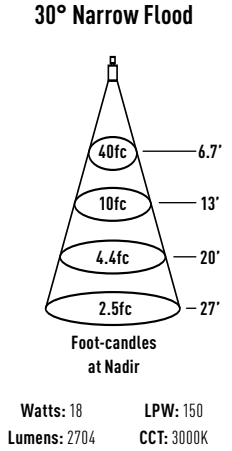

Intensity	
Degree	CBCP
0°	5749
5°	5471
15°	3033
25°	1251
35°	84
45°	27

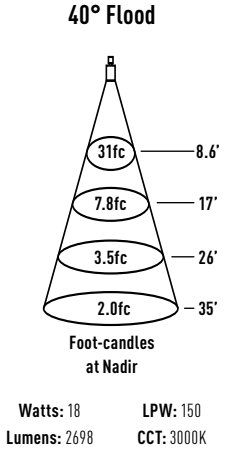

Intensity	
Degree	CBCP
0°	4482
5°	4315
15°	3122
25°	1373
35°	104
45°	36

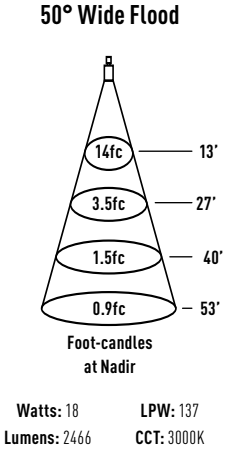

Intensity	
Degree	CBCP
0°	2011
5°	1974
15°	1700
25°	1249
35°	640
45°	217

APPLICATION DATA:

Illuminated width & length are based upon point at which illuminance falls to 50% of center illuminance. Recommended spacing is based upon uniform illuminance aiming angle is the angle between the lamp axis and the perpendicular to the illuminated plane.

W and L are the outer points where the candle power drops to 50% of maximum. FC are the initial foot candles at the center of the beam.

- W Beam width
- L Beam length
- C Distance to center of beam
- D Distance
- FC Footcandles

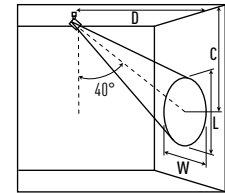
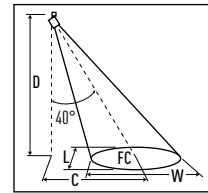
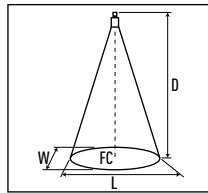

	D	FC	W	L	D	C	FC	W	L	D	C	FC	W	L
GD6ASL430-14 14° Narrow Spot	12'	163.12	3.07	3.15	12'	10.07	73.33	5.44	4.01	6'	7.15	173.29	2.39	3.91
	24'	40.78	6.14	6.31	24'	20.14	18.33	10.88	8.01	12'	14.3	43.32	4.77	7.83
	36'	18.12	9.2	9.46	36'	30.21	8.15	16.32	12.02	18'	21.45	19.25	7.16	11.74
	48'	10.20	12.27	12.62	48'	40.28	4.58	21.76	16.02	24'	28.6	10.83	9.55	15.65
GD6ASL430-20 20° Spot	12'	98.54	4.39	4.39	12'	10.07	44.30	7.67	5.74	6'	7.15	104.68	3.42	5.58
	24'	24.63	8.79	8.79	24'	20.14	11.07	15.34	11.47	12'	14.3	26.17	6.84	11.17
	36'	10.95	13.18	13.18	36'	30.21	4.92	23.01	17.21	18'	21.45	11.63	10.25	16.75
	48'	6.16	17.58	17.58	48'	40.28	2.77	30.68	22.94	24'	28.6	6.54	13.67	22.33
GD6ASL430-30 30° Narrow Flood	12'	49.84	6.69	6.72	12'	10.07	22.41	12.13	8.73	6'	7.15	52.95	5.20	9.16
	24'	12.46	13.38	13.45	24'	20.14	5.60	24.25	17.47	12'	14.3	13.24	10.41	18.31
	36'	5.54	20.07	20.17	36'	30.21	2.49	36.38	26.20	18'	21.45	5.88	15.61	27.47
	48'	3.12	26.76	26.89	48'	40.28	1.40	48.51	34.93	24'	28.6	3.31	20.82	36.63
GD6ASL430-40 40° Flood	12'	38.86	8.61	8.68	12'	10.07	17.47	16.28	11.24	6'	7.15	41.28	6.70	12.89
	24'	9.71	17.23	17.35	24'	20.14	4.37	32.57	22.49	12'	14.3	10.32	13.40	25.78
	36'	4.32	25.84	26.03	36'	30.21	1.94	48.85	33.73	18'	21.45	4.59	20.10	38.68
	48'	2.43	34.45	34.70	48'	40.28	1.09	65.13	44.97	24'	28.6	2.58	26.80	51.57
GD6ASL430-50 50° Wide Flood	12'	17.43	13.34	13.32	12'	10.07	7.84	28.97	17.41	6'	7.15	18.52	10.37	28.64
	24'	4.36	26.67	26.63	24'	20.14	1.96	57.95	34.82	12'	14.30	4.63	20.75	57.28
	36'	1.94	40.01	39.95	36'	30.21	0.87	86.92	52.23	18'	21.45	2.06	31.12	85.91
	48'	1.09	53.35	53.27	48'	40.28	0.49	115.90	69.64	24'	28.6	1.16	41.50	114.55

GRAVITY ADJUSTABLE L/M-049-24-P-8

INTENSE LIGHTING | 3340 E La Palma Ave, Anaheim, CA 92806 | tel 714 630-9877 | fax 714 630-9883

For Intense Lighting's limited product warranty, go to www.intenselight.com. For a printed copy of the warranty, you may call 800 961-5321.

© 2024 Intense Lighting, LLC. All rights reserved. Note: This document is subject to change without notice.

JOB NAME		CATALOG NUMBER	
NOTES		TYPE	

GD6ASL5 ISA600HZ

Report #: ILL20200129-2.001 (14)
ILL20200129-10.001 (20)
ILL20200130-6.001 (30)
ILL20200130-12.001 (40)
ILL20200131-6.001 (50)

CCT MULTIPLIERS:

	82 CRI	92 CRI
2700K	(x 0.95)	(x 0.79)
3000K	(x 1.00)	(x 0.82)
3500K	(x 1.02)	(x 0.85)
4000K	(x 1.03)	(x 0.88)

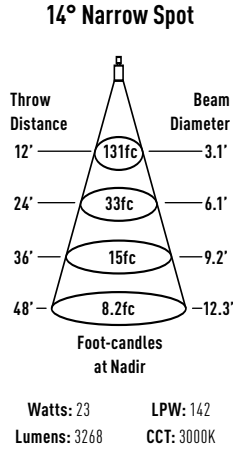

Intensity	
Degree	CBCP
0°	18816
5°	14614
15°	1853
25°	810
35°	65
45°	31

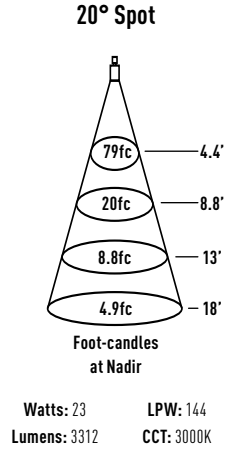

Intensity	
Degree	CBCP
0°	11366
5°	8538
15°	2829
25°	852
35°	51
45°	33

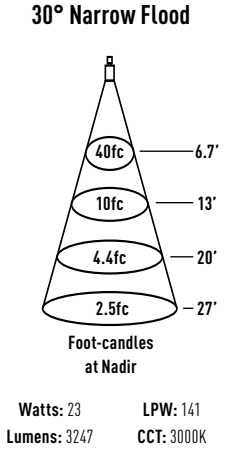

Intensity	
Degree	CBCP
0°	5749
5°	5471
15°	3033
25°	1251
35°	84
45°	27

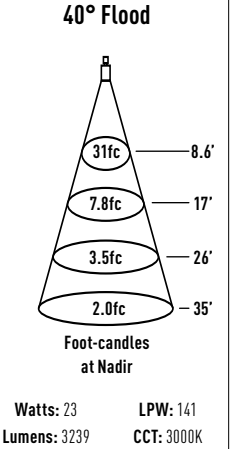

Intensity	
Degree	CBCP
0°	4482
5°	4315
15°	3122
25°	1373
35°	104
45°	36

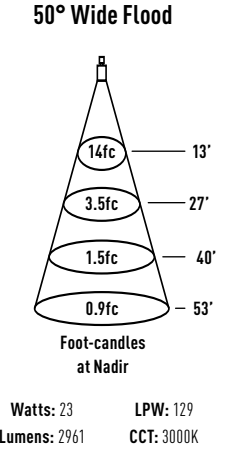

Intensity	
Degree	CBCP
0°	2011
5°	1974
15°	1700
25°	1249
35°	640
45°	217

APPLICATION DATA:

W and L are the outer points where the candle power drops to 50% of maximum. FC are the initial foot candles at the center of the beam.

- W Beam width
- L Beam length
- C Distance to center of beam
- D Distance
- FC Footcandles

Illuminated width & length are based upon point at which illuminance falls to 50% of center illuminance. Recommended spacing is based upon uniform illuminance aiming angle is the angle between the lamp axis and the perpendicular to the illuminated plane.

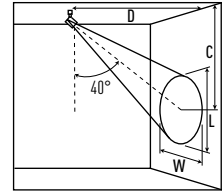
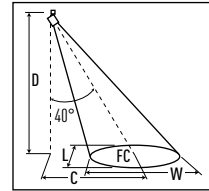
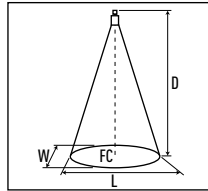

	D	FC	W	L	D	C	FC	W	L	D	C	FC	W	L
GD6ASL530-14 14° Narrow Spot	12'	195.86	3.07	3.15	12'	10.07	88.04	5.44	4.01	6'	7.15	208.07	2.39	3.91
	24'	48.96	6.14	6.31	24'	20.14	22.01	10.88	8.01	12'	14.3	52.02	4.77	7.83
	36'	21.76	9.2	9.46	36'	30.21	9.78	16.32	12.02	18'	21.45	23.12	7.16	11.74
	48'	12.24	12.27	12.62	48'	40.28	5.50	21.76	16.02	24'	28.6	13.00	9.55	15.65
GD6ASL530-20 20° Spot	12'	118.31	4.39	4.39	12'	10.07	53.18	7.67	5.74	6'	7.15	125.69	3.42	5.58
	24'	29.58	8.79	8.79	24'	20.14	13.30	15.34	11.47	12'	14.3	31.42	6.84	11.17
	36'	13.15	13.18	13.18	36'	30.21	5.91	23.01	17.21	18'	21.45	13.97	10.25	16.75
	48'	7.39	17.58	17.58	48'	40.28	3.32	30.68	22.94	24'	28.6	7.86	13.67	22.33
GD6ASL530-30 30° Narrow Flood	12'	59.85	6.69	6.72	12'	10.07	26.90	12.13	8.73	6'	7.15	63.58	5.20	9.16
	24'	14.96	13.38	13.45	24'	20.14	6.73	24.25	17.47	12'	14.3	15.89	10.41	18.31
	36'	6.65	20.07	20.17	36'	30.21	2.99	36.38	26.20	18'	21.45	7.06	15.61	27.47
	48'	3.74	26.76	26.89	48'	40.28	1.68	48.51	34.93	24'	28.6	3.97	20.82	36.63
GD6ASL530-40 40° Flood	12'	46.66	8.61	8.68	12'	10.07	20.97	16.28	11.24	6'	7.15	49.57	6.70	12.89
	24'	11.66	17.23	17.35	24'	20.14	5.24	32.57	22.49	12'	14.3	12.39	13.40	25.78
	36'	5.18	25.84	26.03	36'	30.21	2.33	48.85	33.73	18'	21.45	5.51	20.10	38.68
	48'	2.92	34.45	34.70	48'	40.28	1.31	65.13	44.97	24'	28.6	3.10	26.80	51.57
GD6ASL530-50 50° Wide Flood	12'	20.93	13.34	13.32	12'	10.07	9.41	28.97	17.41	6'	7.15	22.24	10.37	28.64
	24'	5.23	26.67	26.63	24'	20.14	2.35	57.95	34.82	12'	14.30	5.56	20.75	57.28
	36'	2.33	40.01	39.95	36'	30.21	1.05	86.92	52.23	18'	21.45	2.47	31.12	85.91
	48'	1.31	53.35	53.27	48'	40.28	0.59	115.90	69.64	24'	28.6	1.39	41.50	114.55

JOB NAME		CATALOG NUMBER	
NOTES		TYPE	

GD6ASL6 ISA600HZ

Report #: ILL20200129-2.004 (14)
 ILL20200129-10.004 (20)
 ILL20200130-6.004 (30)
 ILL20200130-12.004 (40)
 ILL20200131-6.004 (50)

CCT MULTIPLIERS:

	82 CRI	92 CRI
2700K	(x 0.95)	(x 0.79)
3000K	(x 1.00)	(x 0.82)
3500K	(x 1.02)	(x 0.85)
4000K	(x 1.03)	(x 0.88)

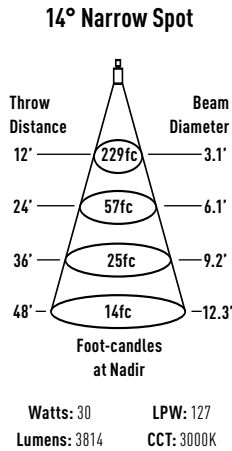

Intensity	
Degree	CBCP
0°	32918
5°	25567
15°	3242
25°	1417
35°	114
45°	54

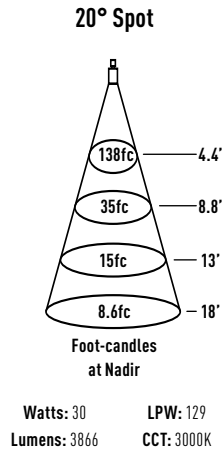

Intensity	
Degree	CBCP
0°	19884
5°	14937
15°	4950
25°	1490
35°	89
45°	58

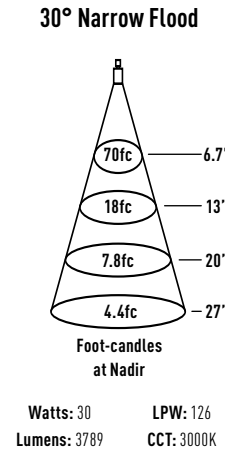

Intensity	
Degree	CBCP
0°	10058
5°	9572
15°	5306
25°	2189
35°	147
45°	48

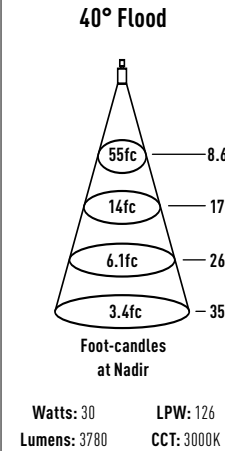

Intensity	
Degree	CBCP
0°	7842
5°	7550
15°	5461
25°	2402
35°	182
45°	63

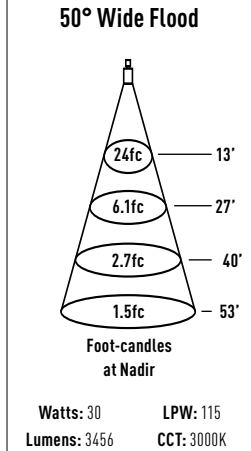

Intensity	
Degree	CBCP
0°	3518
5°	3453
15°	2974
25°	2185
35°	1120
45°	380

APPLICATION DATA:

W and L are the outer points where the candle power drops to 50% of maximum. FC are the initial foot candles at the center of the beam.

- W Beam width
- L Beam length
- C Distance to center of beam
- D Distance
- FC Footcandles

Illuminated width & length are based upon point at which illuminance falls to 50% of center illuminance. Recommended spacing is based upon uniform illuminance aiming angle is the angle between the lamp axis and the perpendicular to the illuminated plane.

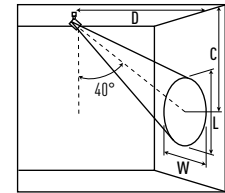
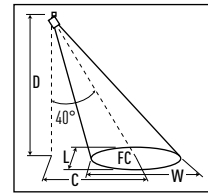
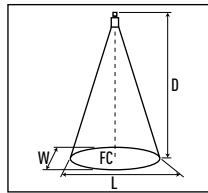

	D	FC	W	L	D	C	FC	W	L	D	C	FC	W	L
GD6ASL630-14 14° Narrow Spot	12'	228.59	3.07	3.15	12'	10.07	102.76	5.44	4.01	6'	7.15	242.84	2.39	3.91
	24'	57.15	6.14	6.31	24'	20.14	25.69	10.88	8.01	12'	14.3	60.71	4.77	7.83
	36'	25.40	9.2	9.46	36'	30.21	11.42	16.32	12.02	18'	21.45	26.98	7.16	11.74
	48'	14.29	12.27	12.62	48'	40.28	6.42	21.76	16.02	24'	28.6	15.18	9.55	15.65
GD6ASL630-20 20° Spot	12'	138.09	4.39	4.39	12'	10.07	62.07	7.67	5.74	6'	7.15	146.69	3.42	5.58
	24'	34.52	8.79	8.79	24'	20.14	15.52	15.34	11.47	12'	14.3	36.67	6.84	11.17
	36'	15.34	13.18	13.18	36'	30.21	6.90	23.01	17.21	18'	21.45	16.30	10.25	16.75
	48'	8.63	17.58	17.58	48'	40.28	3.88	30.68	22.94	24'	28.6	9.17	13.67	22.33
GD6ASL630-30 30° Narrow Flood	12'	69.85	6.69	6.72	12'	10.07	31.40	12.13	8.73	6'	7.15	74.20	5.20	9.16
	24'	17.46	13.38	13.45	24'	20.14	7.85	24.25	17.47	12'	14.3	18.55	10.41	18.31
	36'	7.76	20.07	20.17	36'	30.21	3.49	36.38	26.20	18'	21.45	8.24	15.61	27.47
	48'	4.37	26.76	26.89	48'	40.28	1.96	48.51	34.93	24'	28.6	4.64	20.82	36.63
GD6ASL630-40 40° Flood	12'	54.46	8.61	8.68	12'	10.07	24.48	16.28	11.24	6'	7.15	57.85	6.70	12.89
	24'	13.61	17.23	17.35	24'	20.14	6.12	32.57	22.49	12'	14.3	14.46	13.40	25.78
	36'	6.05	25.84	26.03	36'	30.21	2.72	48.85	33.73	18'	21.45	6.43	20.10	38.68
	48'	3.40	34.45	34.70	48'	40.28	1.53	65.13	44.97	24'	28.6	3.62	26.80	51.57
GD6ASL630-50 50° Wide Flood	12'	24.43	13.34	13.32	12'	10.07	10.98	28.97	17.41	6'	7.15	25.95	10.37	28.64
	24'	6.11	26.67	26.63	24'	20.14	2.75	57.95	34.82	12'	14.30	6.49	20.75	57.28
	36'	2.71	40.01	39.95	36'	30.21	1.22	86.92	52.23	18'	21.45	2.88	31.12	85.91
	48'	1.53	53.35	53.27	48'	40.28	0.69	115.90	69.64	24'	28.6	1.62	41.50	114.55