

MR16-MXASTL

3.5" MX MR16 Square Trimless Adjustable Pinhole

JOB NAME		CATALOG NUMBER	
NOTES		TYPE	

Catalog Number	Lamp Type	Socket Type	Maximum Wattage
MXT-STLx306-GU53	12V MR16	GU5.3	15W LED / 20W Halogen
MXT-STLx306-GU10	120V MR16	GU10	15W LED / 20W Halogen

FEATURES

- New architectural trim finishes available
- 35° Locking vertical and 360° locking horizontal adjustment

LAMP (ORDERED SEPARATELY)

- 12V MR16 GU5.3 LED 15W max. - accommodates lamp diameter up to 1.97" (50.1mm) and MOL of 1.83" (46.4mm)
- 12V MR16 GU5.3 Halogen 20W max. (must use MR16 with front cover glass) - lamp diameter up to 1.97" and MOL of 1.83"
- 120V MR16 GU10 LED 15W max. - accommodates lamp diameter up to 1.97" (50.1mm) and MOL of 2.18" (55.3mm)
- 120V MR16 GU10 Halogen 20W max. - accommodates lamp diameter up to 1.97" (50.1mm) and MOL of 2.18" (55.3mm)

ELECTRICAL SYSTEM

- Power factor >.9, 50/60Hz
- Multiple electronic transformers available, dimming on 120V only
- This product complies with IEEE C62.41 for surge endurance up to 2.5KV. Additional surge protection recommended. Damage from power surge is not covered by warranty.
- Internal thermal and wattage overload protection.

TRANSFORMERS (Check LED compatibility with lamp manufacturer):

- NT - GU10 without transformer with 120V input (20W max.)
- T1 - Hatch RS12-15(X)-LED 120V input/12V output 15W max., no minimum load
- T2 - Hatch RS12-60(X) 120V input/12V output 20W max., no minimum load
- T3 - Hatch RS12-80-277(X) 277V input/12V output 20W max., minimum load 10W (not recommended for LED)

HOUSING

Heavy duty black powder coated 18 gauge steel frame. Standard plaster frame accommodates 5/8" ceiling thickness. Extended collar options available for ceilings up to 1" or 2" thick, must specify.

TRIM SPECIFICATION

Aiming with locking 35° vertical and 360° horizontal adjustment with 1/2" regress and 90° turns (90, 180, 270 and 360) with 1" regress for greater visual comfort. See trim horizontal rotation chart on page 2. High quality trims are die-cast using A380 aluminum and finished with durable powder coat available in multiple finishes, black interior standard. Perforated mesh frame is die-cast to a 0.8mm thickness to easily adhere to joint compound for seamless and trimless mounting. Trims available in 1" regress for greater visual comfort or 1/2" regress for consistent look throughout space.

INSTALLATION

Housing types include IC Air-Tight or Non-IC Rated (must specify). Non-IC rated housings must be kept at a minimum of 3" away from insulation. Butterfly brackets are compatible with adjustable bar hangers (14"-25") and EMT. Bar hangers must be ordered separately. Consult lamp manufacturer for maximum ambient temperature.

ACCESSORIES

Luminaire will accommodate (2) accessories, accessory holder required, see page 2.

LISTINGS

- ETL Listed to US and Canadian standards for damp locations
- (-AIC Only) Air Tight Certified ASTM E283
- (-AIC Only) ETL listed for direct contact w/insulation

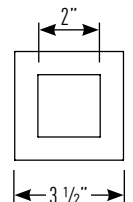
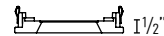
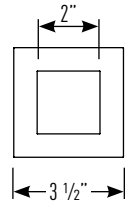
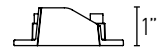
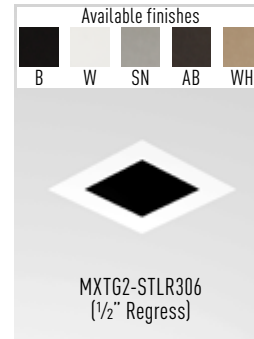
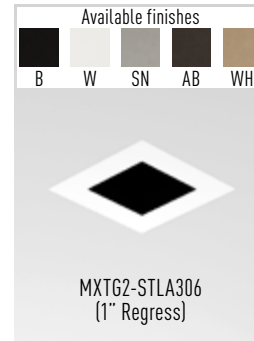

Housing dimensions are on Page 2

Housing Part Number (Example: MR16-MXASTL-ICT1)

Housing	Installation Type	Ceiling Thickness	Transformer	Options
MR16-MXASTL	-NC (Non-IC)	blank (5/8")	NT (GU10 120V No Transformer)	I100 (C-Channel Bar Hangers)
	-IC (Air-Tight IC)	EC1 (1")	T1 (120V/12V RS12-15X-LED)	I200 (Flat Bar Hangers)
		EC2 (2")	T2 (120V/12V RS12-60X)	I400 (Wood Joist Bar Hangers)
			T3 (277V/12V RS12-80X)	

Trim Part Number (Example: MXT-STLA306W-GU53)

Trim	Finish	Base Type
MXT-STLA306 (1" Regress)	B (Black)	-GU53 (12V MR16)
	W (White)	-GU10 (120V MR16)
MXT-STLR306 (1/2" Regress)	SN (Satin Nickel)	
	AB (Antique Bronze)	
	WH (Wheat)	

MR16-MXASTL

3.5" MX MR16 Square Trimless Adjustable Pinhole

JOB NAME		CATALOG NUMBER	
NOTES		TYPE	

NON-IC & AIR TIGHT IC DIMENSIONS

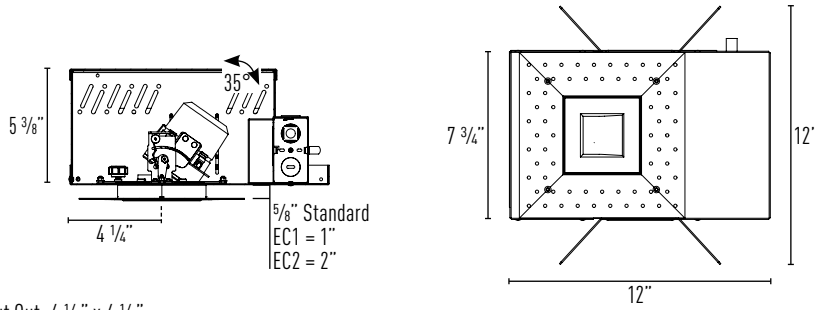

Ceiling Cut Out: 4 1/8" x 4 1/8"

Trim Horizontal Rotation

Trim	Collar Size		
	(blank) = 5/8"	EC1 = 1"	EC2 = 2"
STLA306	90° turns	90° turns	Full 360°
STLR306	Full 360°	Full 360°	Full 360°

ACCESSORIES

Luminaire will accommodate (2) accessories, accessory holder required.

INSTALLATION

1. Remove module from channel and disconnect quick connect.
2. Rotate release cap by turning counter clockwise. Remove two screws on release cap to remove integral sleeve.
3. Install accessories into accessory holder and replace accessory holder's retaining clip.
4. Place accessory holder and accessory against release cap and replace integral sleeve with two screws.
5. Replace release cap.

Accessories

- LH47** (Accessory Holder, Black)
- LH47W** (Accessory Holder, White)
- PFLMB-47** (Hex Louver, Black)
- PFL1-47** (Prismatic Spread Lens)
- PFL2-47** (Linear Spread Lens)
- PFL4-47** (Soft Focus Lens)

