

# MR16-MXDSTL

3.5" MX MR16 Square Trimless Lensed Pinhole - Wet Location

JOB NAME		CATALOG NUMBER	
NOTES		TYPE	

Catalog Number	Lamp Type	Socket Type	Maximum Wattage
<b>MXT-STLx308-GU53</b>	12V MR16	GU5.3	15W LED / 20W Halogen
<b>MXT-STLx308-GU10</b>	120V MR16	GU10	15W LED / 20W Halogen

### LAMP (ORDERED SEPARATELY)

- 12V MR16 GU5.3 LED 15W max. - accommodates lamp diameter up to 1.97" (50.1mm) and MOL of 1.83" (46.4mm)
- 12V MR16 GU5.3 Halogen 20W max. (must use MR16 with front cover glass) - lamp diameter up to 1.97" and MOL of 1.83"
- 120V MR16 GU10 LED 15W max. - accommodates lamp diameter up to 1.97" (50.1mm) and MOL of 2.18" (55.3mm)
- 120V MR16 GU10 Halogen 20W max. - accommodates lamp diameter up to 1.97" (50.1mm) and MOL of 2.18" (55.3mm)

### ELECTRICAL SYSTEM

- Power factor >.9, 50/60Hz
- Multiple electronic transformers available, dimming on 120V only
- This product complies with IEEE C62.41 for surge endurance up to 2.5KV. Additional surge protection recommended. Damage from power surge is not covered by warranty.
- Internal thermal and wattage overload protection.

### TRANSFORMERS (Check LED compatibility with lamp manufacturer):

- NT - GU10 without transformer with 120V input (20W max.)
- T1 - Hatch RS12-15(X)-LED 120V input/12V output 15W max., no minimum load
- T2 - Hatch RS12-60(X) 120V input/12V output 20W max., no minimum load
- T3 - Hatch RS12-80-277(X) 277V input/12V output 20W max., minimum load 10W (not recommended for LED)

### HOUSING

Heavy duty black powder coated 18 gauge steel frame. Standard plaster frame accommodates 5/8" ceiling thickness. Extended collar options available for ceilings up to 1" or 2" thick, must specify.

### TRIM SPECIFICATION

High quality trims are die-cast using A380 aluminum and finished with durable powder coat available in multiple finishes, black interior standard. Trim is available with solite, clear tempered or frosted lens, must specify. Trims available in 1 1/2" regress for greater visual comfort or 1/2" regress for consistent look throughout space.

### INSTALLATION

Housing types include IC Air-Tight or Non-IC Rated (must specify). Non-IC rated housings must be kept at a minimum of 3" away from insulation. Butterfly brackets are compatible with adjustable bar hangers (14"-25") and EMT. Bar hangers must be ordered separately. Consult lamp manufacturer for maximum ambient temperature.

### LISTINGS

- ETL Listed to US and Canadian standards for wet locations
- (-AIC Only) Air Tight Certified ASTM E283
- (-AIC Only) ETL listed for direct contact w/insulation

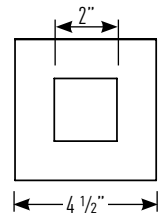
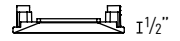
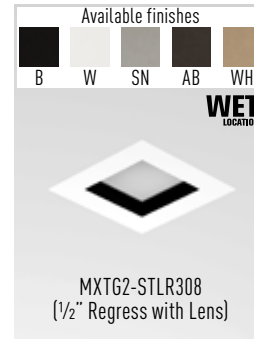
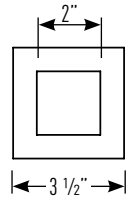
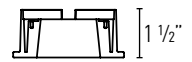
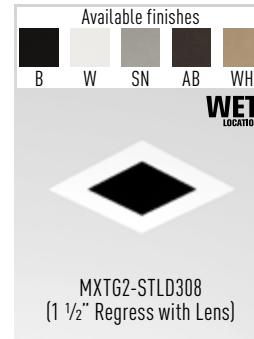

Housing dimensions are on Page 2

### Housing Part Number (Example: MR16-MXDSTL-ICT1)

Housing	Installation Type	Ceiling Thickness	Transformer	Options
MR16-MXDSTL	-NC (Non-IC)	blank (5/8")	NT (GU10 120V No Transformer)	I200 (Flat Bar Hangers)
	-IC (Air-Tight IC)	EC1 (1")	T1 (120V/12V RS12-15X-LED)	I400 (Wood Joist Bar Hangers)
		EC2 (2")	T2 (120V/12V RS12-60X)	
			T3 (277V/12V RS12-80X)	

### Trim Part Number (Example: MXT-STLD308W-GU53-CR)

Trim	Finish	Base Type	Lens
MXT-STLD308 (1 1/2" Regress)	B (Black)	-GU53 (12V MR16)	-SL (Solite)
	W (White)	-GU10 (120V MR16)	-CR (Clear Tempered)
MXT-STLR308 (1/2" Regress)	SN (Satin Nickel)		-FR (Frosted)
	AB (Antique Bronze)		
	WH (Wheat)		

# MR16-MXDSTL

3.5" MX MR16 Square Trimless Lensed Pinhole - Wet Location

<b>JOB NAME</b>		<b>CATALOG NUMBER</b>	
<b>NOTES</b>		<b>TYPE</b>	

## NON-IC & AIR TIGHT IC DIMENSIONS

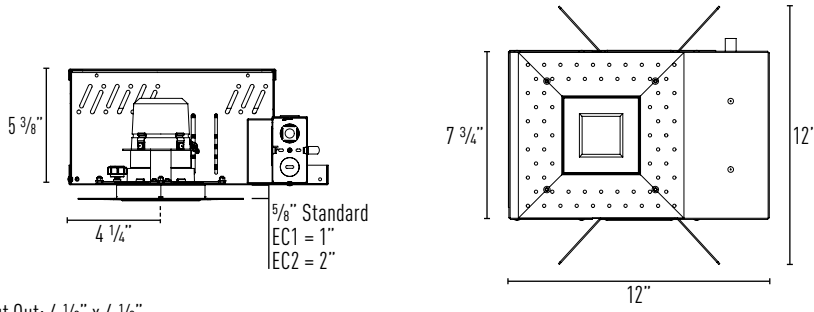

Ceiling Cut Out: 4 1/8" x 4 1/8"