

MXG2ASTL

3.5" MX G2 LED Square Trimless Lensed Adjustable - Wet Location

JOB NAME		CATALOG NUMBER	
NOTES		TYPE	

ELECTRICAL DATA

LED Light Engine	System Wattage *	CCT / CRI	Delivered Lumens **	Lumens Per Watt
L0	10W	3000K / 82 CRI	800lm	80
L1	16W	3000K / 82 CRI	1100lm	69
L2	20W	3000K / 82 CRI	1300lm	65
L3	26W	3000K / 82 CRI	1600lm	62

*System Wattage include driver and LED Module consumption. **Delivered lumens will vary depending on trim, CCT, CRI, optic and ceiling thickness

FEATURES

- Multiple architectural trim options
- High center beam spot up to 21,500 CBCP
- Dedicated 9° with field changeable 12°, 24°, 36° & 50° optics

LED LIGHT ENGINE

- 92 CRI & 82 CRI in 2700K, 3000K, 3500K or 4100K with 2SDCM binning
- >50,000 hours L70 (rated life at 70% output)

ELECTRICAL SYSTEM

- (Non-IC) Dedicated voltage options of 120V or 277V. Must be specified in catalog code.
- (-IC) Universal 120V/277V input; Power factor >.9 50/60Hz
- This product complies with IEEE C62.41 for surge endurance up to 2.5KV. Additional surge protection recommended. Damage from power surge is not covered by warranty.

DIMMING

- 0-10V Dimming 1%
- Forward/reverse dimming 1% (120V only)
- EldoLED 0-10V 0.1% or 1%
- Lutron® LDE1 Hi-Lume 1% EcoSystem LED driver with Soft-on, Fade-to-Black dimming technology
- DMX512 RDM 0.1%

HOUSING

- Heavy duty black powder coated 18 gauge steel frame
- Standard housing accommodates 5/8" ceiling thickness
- Extended collar options available for ceilings up to 1" or 2" thick, must specify either EC1 or EC2

TRIM SPECIFICATION

Aiming with locking 35° vertical and 360° horizontal adjustment. High quality trims are die-cast using A380 aluminum with durable powder coat available in multiple finishes. Perforated mesh frame is die-cast to a 0.8mm thickness to easily adhere to joint compound for seamless and trimless mounting. Trim is available with solite, clear tempered or frosted lens, must specify.

INSTALLATION

Housing types include IC Air-Tight or Non-IC Rated (must specify). Non-IC rated housings must be kept at a minimum of 3" away from insulation. Butterfly brackets are compatible with adjustable bar hangers (14"-25") and EMT. Bar hangers must be ordered separately. Max. ambient temperature: 95°F (35°C).

EMERGENCY BACKUP

Remote test switch included. External battery operates LED load at a minimum of 350 to 600 lumens for 90 minutes, depending on backup wattage selected. See trim multipliers for detailed performance. Servicing requires above ceiling access.

LISTING / WARRANTY

- 5-Year Intense LED Limited Warranty
- ETL listed to US and Canadian standards for wet locations
- (-IC Only) Air-Tight Certified ASTM E283
- (-IC Only) ETL listed for direct contact w/insulation
- ENERGY STAR® Qualified ¹
- Can be used to comply with 2016 Title 24, Part 6, JA8 high efficacy LED light source requirements ²

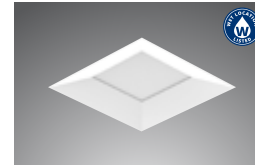

MXTG2-STLR302
(1/2" Regress with Lens)

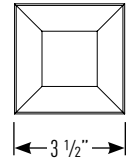
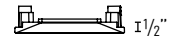

Housing dimensions are on Page 2

Available Trim Finishes



Housing Part Number (Example: MXG2ASTL-ICL1)

Housing	Installation Type	Ceiling Thickness	Wattage	Dimming	Voltage	Options
MXG2ASTL	-NC (Non-IC)	blank (5/8")	L0 (10W)	blank (Non-Dimming)	blank (Non-IC: 120V -IC: 120V/277V)	1100 (C-Channel Bar Hangers)
		EC1 (1")	L1 (16W)	DELV* (Phase Dimming)		1200 (Flat Bar Hangers)
	-IC (Air-Tight IC)	EC2 (2")	L2 (20W)	D101 (0-10V Dimming 1%)	27 (277V Non-IC Only, for -IC housing options use blank)	1400 (Wood Joist Bar Hangers)
			L3 ³ (26W)	ED10V1 ⁵ (eldoLED 0-10V 1%) ED10V01 ⁵ (eldoLED 0-10V 0.1%)		EM7 ⁸ (7W Emergency Backup IOTA Part #ILB-CP07-A)
			LUT ⁶ (Lutron® LDE1 EcoSystem 1%) DMXR ⁷ (DMX512 RDM 0.1%)		EM12 ^{8,9} (12W Emergency Backup IOTA Part #ILB-CP12-A)	

Trim Part Number (Example: MXTG2-STLR302W-SFL13024-SL)

Trim	Finish	Wattage	CCT / CRI	Optic	Lens	
MXTG2-STLR302 (1/2" Regress)	W (White)	L0 (10W)	27 (2700K / 82 CRI)	09 ¹⁰ (9° Narrow Spot)	-SL (Solite)	
	B (Black)	L1 (16W)	279 (2700K / 92 CRI)	12 (12° Spot)	-CR (Clear Tempered)	
	SN (Satin Nickel)	L2 (20W)	30 (3000K / 82 CRI)	24 (24° Narrow Flood)	-FR (Frosted)	
	AB (Antique Bronze)	L3 ³ (26W)	309 (3000K / 92 CRI)	36 (36° Flood)	50 (50° Wide Flood)	
			35 (3500K / 82 CRI)			
			359 (3500K / 92 CRI)			
			41 (4100K / 82 CRI)			
			419 (4100K / 92 CRI)			

Notes:

- ENERGY STAR® Qualified (White reflectors only; Excludes: L2, L3, 92 CRI & 9° options)
- L0 only; Excludes: 82 CRI & 9° options
- L3 available with Non-IC housings only
- Available in 120V only
- Not Available in L3
- Not Available in L2 & L3
- DMX512 RDM not available in L0 & L1
- Access above ceiling required
- Not available in L0
- 9° NS available in 279 with L0 or L1 Only

MXG2ASTL

3.5" MX G2 LED Square Trimless Lensed Adjustable - Wet Location

JOB NAME		CATALOG NUMBER	
NOTES		TYPE	

NON-IC & AIR TIGHT IC DIMENSIONS

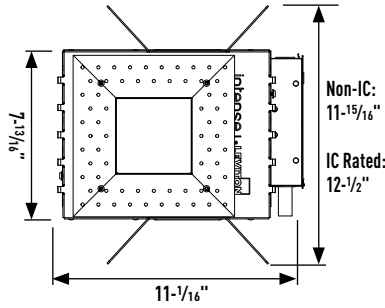
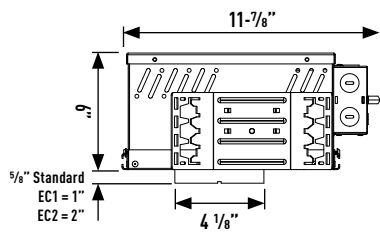

Ceiling Cut Out: 4 1/8"

Plaster Frame Accommodation

Collar Type	Standard	EC1	EC2
Max Ceiling Thickness	Up-to 5/8"	Up-to 1"	Up-to 2"

Fixture Aiming - Horizontal Adjustment

1/2" Regress Trims	Full 360°	Full 360°	Full 360°

OPTICS REPLACEMENT

1. Rotate release cap by turning counter clockwise.
2. Install accessories into accessory holder and replace accessory holder's retaining clip.
3. Place accessory holder and accessory flush against optic and replace release cap.

Optics

- IP-OP4712 (12° Spot)
- IP-OP4724 (24° Narrow Flood)
- IP-OP4736 (36° Flood)
- IP-OP4750 (50° Wide Flood)

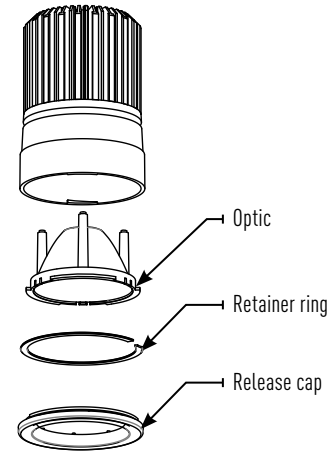

JOB NAME		CATALOG NUMBER	
NOTES		TYPE	

MXTG2-STLR302WLO-CR

Report #: ILL-02222016-01.3 (12)
 ILL-02222016-02.3 (24)
 ILL-02222016-03.3 (36)
 ILL-02222016-04.3 (50)

MXTG2-STLR302
 Ceiling Thickness Multipliers:
 5/8" Thickness (x 1.00)
 1" Thickness (x 0.77)
 2" Thickness (x 0.56)

CCT MULTIPLIERS:

	82 CRI	92 CRI
2700K	(x 0.93)	(x 0.76)
3000K	(x 1.00)	(x 0.87)
3500K	(x 1.00)	(x 0.87)
4100K	(x 1.00)	(x 0.87)

LENS MULTIPLIERS:

Solite	(x 0.92)
Clear	(x 1.00)
Frosted	(x 0.92)

EMERGENCY MULTIPLIER:

7W Emergency	(x 0.70)
--------------	----------

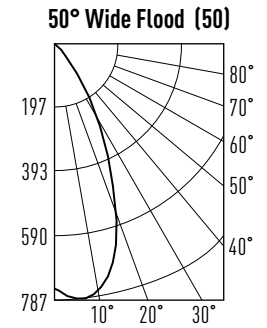
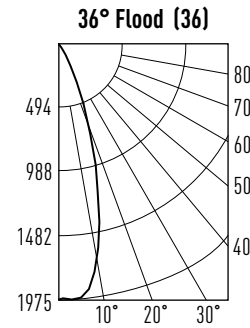
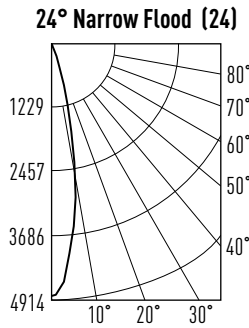
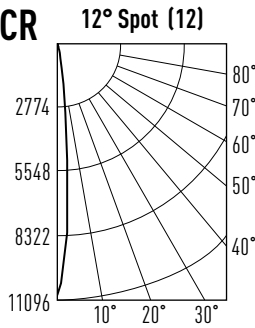

Watts: 10
 Lumens: 763
 LPW: 76
 CCT: 3000K

Watts: 10
 Lumens: 803
 LPW: 80
 CCT: 3000K

Watts: 10
 Lumens: 757
 LPW: 76
 CCT: 3000K

Watts: 10
 Lumens: 646
 LPW: 65
 CCT: 3000K

Candelas at Nadir

Degree	Candela
0°	10821
5°	4189
15°	381
25°	95
35°	32
45°	5

Candelas at Nadir

Degree	Candela
0°	4823
5°	4024
15°	1203
25°	147
35°	19
45°	2

Candelas at Nadir

Degree	Candela
0°	1969
5°	1963
15°	1169
25°	353
35°	71
45°	7

Candelas at Nadir

Degree	Candela
0°	751
5°	785
15°	693
25°	396
35°	161
45°	43

APPLICATION DATA:

W and **L** are the outer points where the candle power drops to 50% of maximum. **FC** are the initial footcandles at the center of the beam.

- W** Beam width
- L** Beam length
- C** Distance to center of beam
- D** Distance
- FC** Footcandles

Illuminated width & length are based upon point at which illuminance falls to 50% of center illuminance. Recommended spacing is based upon uniform illuminance aiming angle is the angle between the lamp axis and the perpendicular to the illuminated plane.

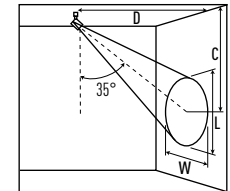
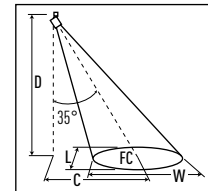
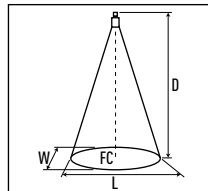

	0° HORIZONTAL				35° HORIZONTAL				35° VERTICAL					
	D	FC	W	L	D	C	FC	W	L	D	C	FC	W	L
MXTG2-STLR302WLO-CR 3000K 12° Spot	6'	301	1.3	1.4	6'	4	176	1.98	1.49	3'	4	282	1.15	2.42
	8'	169	1.8	1.8	8'	5	105	2.58	2.1	4'	6	176	1.49	2.96
	10'	108	2.2	2.3	10'	6	66.2	3.13	2.67	5'	7	115	1.89	3.48
	12'	75.1	2.7	2.7	12'	7	45.4	3.82	3.19	6'	9	78.2	2.55	4.24
MXTG2-STLR302WLO-CR 3000K 24° Narrow Flood	6'	134	2.4	2.2	6'	4	78.2	3.2	2.64	3'	4	150	1.78	3.22
	8'	75.4	3.2	3	8'	5	45	4.19	3.35	4'	5	83.4	2.5	4.28
	10'	48.2	4	3.7	10'	6	29	5.22	4.16	5'	7	52.9	3.15	5.36
	12'	33.5	4.8	4.4	12'	6	20.2	6.24	5.03	6'	8	37.5	3.65	6.31
MXTG2-STLR302WLO-CR 3000K 36° Flood	6'	54.7	3.9	3.5	6'	3	35	4.6	3.63	3'	3	66.4	2.76	4
	8'	30.8	5.2	4.7	8'	4	19.7	6.16	5.01	4'	5	37.5	3.46	5.34
	10'	19.7	6.5	5.8	10'	5	12.6	7.67	6.27	5'	6	24.7	4.33	6.47
	12'	13.7	7.8	7	12'	6	8.8	9.21	7.48	6'	7	17.4	5.13	7.64
MXTG2-STLR302WLO-CR 3000K 50° Wide Flood	6'	20.9	6.2	5.8	6'	2	15.6	5.76	5.32	3'	3	30.2	3.46	4.18
	8'	11.7	8.2	7.8	8'	3	8.7	7.76	7.19	4'	4	17	4.7	5.5
	10'	7.5	10.3	9.7	10'	3	5.6	9.68	8.97	5'	5	10.9	5.84	6.89
	12'	5.2	12.4	11.7	12'	4	3.9	11.51	10.67	6'	6	7.5	6.99	8.2

JOB NAME		CATALOG NUMBER	
NOTES		TYPE	

MXTG2-STLR302WL1-CR

Report #: ILL-02222016-01.2 (12)
 ILL-02222016-02.2 (24)
 ILL-02222016-03.2 (36)
 ILL-02222016-04.2 (50)

MXTG2-STLR302
 Ceiling Thickness Multipliers:
 5/8" Thickness (x 1.00)
 1" Thickness (x 0.77)
 2" Thickness (x 0.56)

CCT MULTIPLIERS:

	82 CRI	92 CRI
2700K	(x 0.93)	(x 0.76)
3000K	(x 1.00)	(x 0.87)
3500K	(x 1.00)	(x 0.87)
4100K	(x 1.00)	(x 0.87)

LENS MULTIPLIERS:

Solite	(x 0.92)
Clear	(x 1.00)
Frosted	(x 0.92)

EMERGENCY MULTIPLIER:

7W Emergency	(x 0.50)
12W Emergency	(x 0.85)

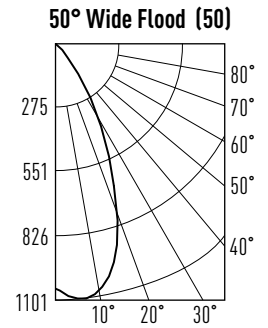
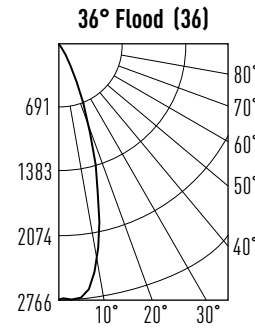
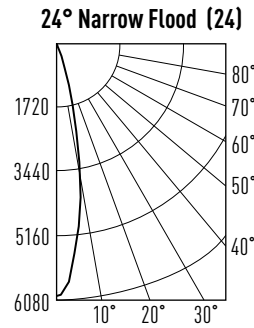
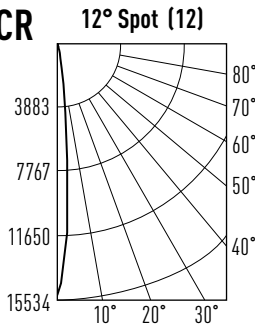

Watts: 15.4
 Lumens: 1072
 LPW: 70
 CCT: 3000K

Watts: 15.5
 Lumens: 1124
 LPW: 73
 CCT: 3000K

Watts: 15.5
 Lumens: 1060
 LPW: 68
 CCT: 3000K

Watts: 15.5
 Lumens: 905
 LPW: 58
 CCT: 3000K

Candelas at Nadir

Degree	Candela
0°	15149
5°	5864
15°	533
25°	133
35°	45
45°	6

Candelas at Nadir

Degree	Candela
0°	6752
5°	5633
15°	1684
25°	206
35°	26
45°	3

Candelas at Nadir

Degree	Candela
0°	2757
5°	2748
15°	1636
25°	494
35°	100
45°	9

Candelas at Nadir

Degree	Candela
0°	1051
5°	1098
15°	971
25°	555
35°	225
45°	60

APPLICATION DATA:

W and **L** are the outer points where the candle power drops to 50% of maximum. **FC** are the initial footcandles at the center of the beam.

- W** Beam width
- L** Beam length
- C** Distance to center of beam
- D** Distance
- FC** Footcandles

Illuminated width & length are based upon point at which illuminance falls to 50% of center illuminance. Recommended spacing is based upon uniform illuminance aiming angle is the angle between the lamp axis and the perpendicular to the illuminated plane.

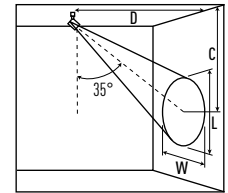
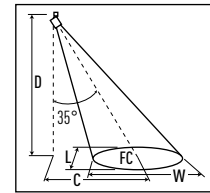
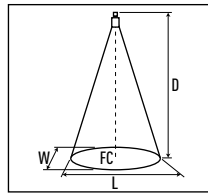

	0° HORIZONTAL				35° HORIZONTAL				35° VERTICAL					
	D	FC	W	L	D	C	FC	W	L	D	C	FC	W	L
MXTG2-STLR302WL1-CR 3000K 12° Spot	6'	421	1.3	1.4	6'	4	246	1.98	1.49	3'	4	395	1.15	2.42
	8'	237	1.8	1.8	8'	5	147	2.58	2.1	4'	6	246	1.49	2.96
	10'	151	2.2	2.3	10'	6	92.7	3.13	2.67	5'	7	161	1.89	3.48
	12'	105	2.7	2.7	12'	7	63.6	3.82	3.19	6'	9	110	2.55	4.24
MXTG2-STLR302WL1-CR 3000K 24° Narrow Flood	6'	188	2.4	2.2	6'	4	109	3.2	2.64	3'	4	210	1.78	3.22
	8'	105	3.2	3	8'	5	63.1	4.19	3.35	4'	5	117	2.5	4.28
	10'	67.5	4	3.7	10'	6	40.6	5.22	4.16	5'	7	74	3.15	5.36
	12'	46.9	4.8	4.4	12'	6	28.3	6.24	5.03	6'	8	52.5	3.65	6.31
MXTG2-STLR302WL1-CR 3000K 36° Flood	6'	76.6	3.9	3.5	6'	3	49	4.6	3.63	3'	3	92.9	2.76	4
	8'	43.1	5.2	4.7	8'	4	27.6	6.16	5.01	4'	5	52.6	3.46	5.34
	10'	27.6	6.5	5.8	10'	5	17.7	7.67	6.27	5'	6	34.6	4.33	6.47
	12'	19.1	7.8	7	12'	6	12.3	9.21	7.48	6'	7	24.3	5.13	7.64
MXTG2-STLR302WL1-CR 3000K 50° Wide Flood	6'	29.2	6.2	5.8	6'	2	21.8	5.76	5.32	3'	3	42.3	3.46	4.18
	8'	16.4	8.2	7.8	8'	3	12.2	7.76	7.19	4'	4	23.8	4.7	5.5
	10'	10.5	10.3	9.7	10'	3	7.8	9.68	8.97	5'	5	15.2	5.84	6.89
	12'	7.3	12.4	11.7	12'	4	5.5	11.51	10.67	6'	6	10.6	6.99	8.2

JOB NAME		CATALOG NUMBER	
NOTES		TYPE	

MXTG2-STLR302WL2-CR

Report #: ILL-02222016-01.1 (12)
 ILL-02222016-02.1 (24)
 ILL-02222016-03.1 (36)
 ILL-02222016-04.1 (50)

MXTG2-STLR302
 Ceiling Thickness Multipliers:
 5/8" Thickness (x 1.00)
 1" Thickness (x 0.77)
 2" Thickness (x 0.56)

CCT MULTIPLIERS:

	82 CRI	92 CRI
2700K	(x 0.93)	(x 0.76)
3000K	(x 1.00)	(x 0.87)
3500K	(x 1.00)	(x 0.87)
4100K	(x 1.00)	(x 0.87)

LENS MULTIPLIERS:

Solite	(x 0.92)
Clear	(x 1.00)
Frosted	(x 0.92)

EMERGENCY MULTIPLIER:

7W Emergency	(x 0.40)
12W Emergency	(x 0.68)

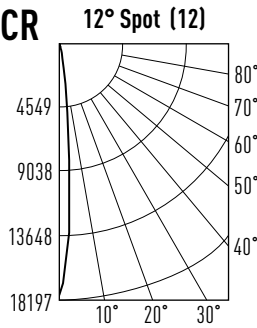

Watts: 20.5
 Lumens: 1251
 LPW: 61
 CCT: 3000K

Candelas at Nadir

Degree	Candela
0°	17746
5°	6869
15°	625
25°	156
35°	53
45°	7

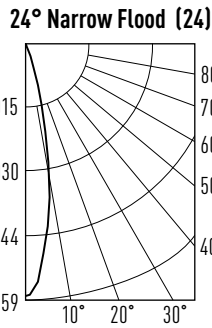

Watts: 20.4
 Lumens: 1317
 LPW: 65
 CCT: 3000K

Candelas at Nadir

Degree	Candela
0°	7909
5°	6599
15°	1972
25°	241
35°	30
45°	4

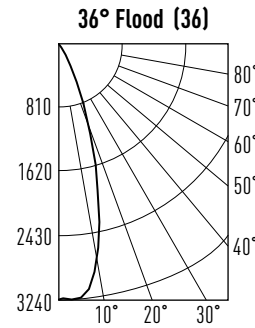

Watts: 20.5
 Lumens: 1242
 LPW: 61
 CCT: 3000K

Candelas at Nadir

Degree	Candela
0°	3230
5°	3219
15°	1916
25°	579
35°	117
45°	11

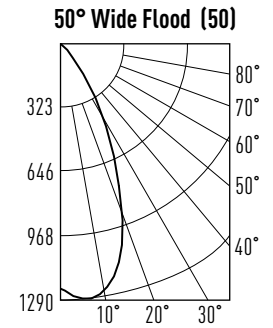

Watts: 20.4
 Lumens: 1060
 LPW: 52
 CCT: 3000K

Candelas at Nadir

Degree	Candela
0°	1231
5°	1287
15°	1137
25°	650
35°	263
45°	70

APPLICATION DATA:

W and **L** are the outer points where the candle power drops to 50% of maximum. **FC** are the initial footcandles at the center of the beam.

W Beam width
L Beam length
C Distance to center of beam
D Distance
FC Footcandles

Illuminated width & length are based upon point at which illuminance falls to 50% of center illuminance. Recommended spacing is based upon uniform illuminance aiming angle is the angle between the lamp axis and the perpendicular to the illuminated plane.

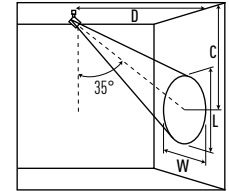
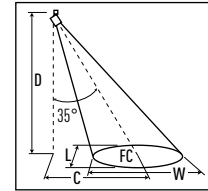
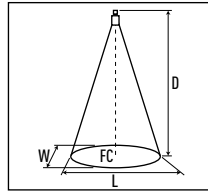

	0° HORIZONTAL				35° HORIZONTAL				35° VERTICAL					
	D	FC	W	L	D	C	FC	W	L	D	C	FC	W	L
MXTG2-STLR302WL2-CR 3000K 12° Spot	6'	493	1.3	1.4	6'	4	289	1.98	1.49	3'	4	463	1.15	2.42
	8'	277	1.8	1.8	8'	5	172	2.58	2.1	4'	6	289	1.49	2.96
	10'	177	2.2	2.3	10'	6	109	3.13	2.67	5'	7	188	1.89	3.48
	12'	123	2.7	2.7	12'	7	74.5	3.82	3.19	6'	9	128	2.55	4.24
MXTG2-STLR302WL2-CR 3000K 24° Narrow Flood	6'	220	2.4	2.2	6'	4	128	3.2	2.64	3'	4	246	1.78	3.22
	8'	124	3.2	3	8'	5	73.9	4.19	3.35	4'	5	137	2.5	4.28
	10'	79.1	4	3.7	10'	6	47.6	5.22	4.16	5'	7	86.7	3.15	5.36
	12'	54.9	4.8	4.4	12'	6	33.2	6.24	5.03	6'	8	61.5	3.65	6.31
MXTG2-STLR302WL2-CR 3000K 36° Flood	6'	89.7	3.9	3.5	6'	3	57.4	4.6	3.63	3'	3	109	2.76	4
	8'	50.5	5.2	4.7	8'	4	32.3	6.16	5.01	4'	5	61.6	3.46	5.34
	10'	32.3	6.5	5.8	10'	5	20.7	7.67	6.27	5'	6	40.6	4.33	6.47
	12'	22.4	7.8	7	12'	6	14.4	9.21	7.48	6'	7	28.5	5.13	7.64
MXTG2-STLR302WL2-CR 3000K 50° Wide Flood	6'	34.2	6.2	5.8	6'	2	25.6	5.76	5.32	3'	3	49.5	3.46	4.18
	8'	19.2	8.2	7.8	8'	3	14.2	7.76	7.19	4'	4	27.8	4.7	5.5
	10'	12.3	10.3	9.7	10'	3	9.1	9.68	8.97	5'	5	17.8	5.84	6.89
	12'	8.6	12.4	11.7	12'	4	6.4	11.51	10.67	6'	6	12.4	6.99	8.2

JOB NAME		CATALOG NUMBER	
NOTES		TYPE	

MXTG2-STLR302WL3-CR

Report #: ILL-02222016-01 (12)
 ILL-02222016-02 (24)
 ILL-02222016-03 (36)
 ILL-02222016-04 (50)

MXTG2-STLR302
 Ceiling Thickness Multipliers:
 5/8" Thickness (x 1.00)
 1" Thickness (x 0.77)
 2" Thickness (x 0.56)

CCT MULTIPLIERS:

	82 CRI	92 CRI
2700K	(x 0.93)	(x 0.76)
3000K	(x 1.00)	(x 0.87)
3500K	(x 1.00)	(x 0.87)
4100K	(x 1.00)	(x 0.87)

LENS MULTIPLIERS:

Solite	(x 0.92)
Clear	(x 1.00)
Frosted	(x 0.92)

EMERGENCY MULTIPLIER:

7W Emergency	(x 0.35)
12W Emergency	(x 0.59)

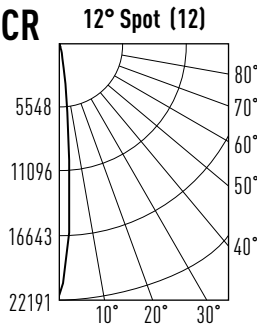

Watts: 26
 Lumens: 1526
 LPW: 59
 CCT: 3000K

Candelas at Nadir

Degree	Candela
0°	21641
5°	8377
15°	762
25°	190
35°	64
45°	9

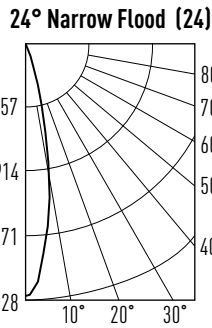

Watts: 26
 Lumens: 1606
 LPW: 62
 CCT: 3000K

Candelas at Nadir

Degree	Candela
0°	9646
5°	8047
15°	2405
25°	294
35°	37
45°	5

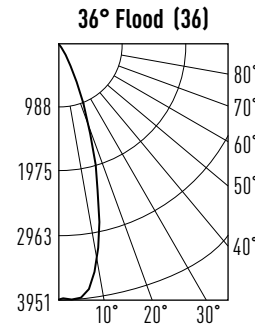

Watts: 26
 Lumens: 1515
 LPW: 58
 CCT: 3000K

Candelas at Nadir

Degree	Candela
0°	3938
5°	3925
15°	2337
25°	706
35°	142
45°	14

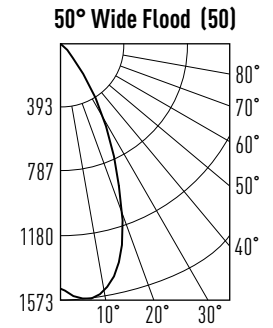

Watts: 26
 Lumens: 1292
 LPW: 50
 CCT: 3000K

Candelas at Nadir

Degree	Candela
0°	1502
5°	1569
15°	1387
25°	792
35°	321
45°	86

APPLICATION DATA:

W and **L** are the outer points where the candle power drops to 50% of maximum. **FC** are the initial footcandles at the center of the beam.

- W** Beam width
- L** Beam length
- C** Distance to center of beam
- D** Distance
- FC** Footcandles

Illuminated width & length are based upon point at which illuminance falls to 50% of center illuminance. Recommended spacing is based upon uniform illuminance aiming angle is the angle between the lamp axis and the perpendicular to the illuminated plane.

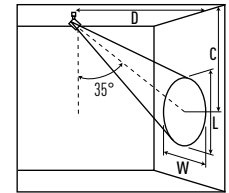
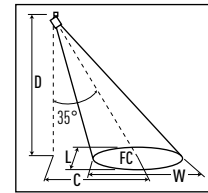
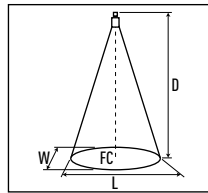

	0° HORIZONTAL				35° HORIZONTAL				35° VERTICAL					
	D	FC	W	L	D	C	FC	W	L	D	C	FC	W	L
MXTG2-STLR302WL3-CR 3000K 12° Spot	6'	601	1.3	1.4	6'	4	352	1.98	1.49	3'	4	565	1.15	2.42
	8'	338	1.8	1.8	8'	5	210	2.58	2.1	4'	6	352	1.49	2.96
	10'	216	2.2	2.3	10'	6	132	3.13	2.67	5'	7	229	1.89	3.48
	12'	150	2.7	2.7	12'	7	90.8	3.82	3.19	6'	9	157	2.55	4.24
MXTG2-STLR302WL3-CR 3000K 24° Narrow Flood	6'	268	2.4	2.2	6'	4	156	3.2	2.64	3'	4	300	1.78	3.22
	8'	151	3.2	3	8'	5	90.1	4.19	3.35	4'	5	167	2.5	4.28
	10'	96.5	4	3.7	10'	6	58	5.22	4.16	5'	7	106	3.15	5.36
	12'	67	4.8	4.4	12'	6	40.4	6.24	5.03	6'	8	75	3.65	6.31
MXTG2-STLR302WL3-CR 3000K 36° Flood	6'	109	3.9	3.5	6'	3	70	4.6	3.63	3'	3	133	2.76	4
	8'	61.5	5.2	4.7	8'	4	39.4	6.16	5.01	4'	5	75.1	3.46	5.34
	10'	39.4	6.5	5.8	10'	5	25.2	7.67	6.27	5'	6	49.5	4.33	6.47
	12'	27.4	7.8	7	12'	6	17.5	9.21	7.48	6'	7	34.8	5.13	7.64
MXTG2-STLR302WL3-CR 3000K 50° Wide Flood	6'	41.7	6.2	5.8	6'	2	31.2	5.76	5.32	3'	3	60.4	3.46	4.18
	8'	23.5	8.2	7.8	8'	3	17.4	7.76	7.19	4'	4	34	4.7	5.5
	10'	15	10.3	9.7	10'	3	11.1	9.68	8.97	5'	5	21.7	5.84	6.89
	12'	10.4	12.4	11.7	12'	4	7.8	11.51	10.67	6'	6	15.1	6.99	8.2