

# MXG2ASTL

## 3.5" MX G2 LED Square Trimless Lensed Pinhole - Wet Location

JOB NAME		CATALOG NUMBER	
NOTES		TYPE	

### ELECTRICAL DATA

LED Light Engine	System Wattage *	CCT / CRI	Delivered Lumens **	Lumens Per Watt
L0	10W	3000K / 82 CRI	650lm	65
L1	16W	3000K / 82 CRI	950lm	59
L2	20W	3000K / 82 CRI	1100lm	55
L3	26W	3000K / 82 CRI	1350lm	52

\*System Wattage include driver and LED Module consumption. \*\*Delivered lumens will vary depending on trim, CCT, CRI, optic and ceiling thickness

### FEATURES

- Multiple architectural trim options
- High center beam spot up to 21,000 CBCP
- Dedicated 9° with field changeable 12°, 24°, 36° & 50° optics

### LED LIGHT ENGINE

- 92 CRI & 82 CRI in 2700K, 3000K, 3500K or 4100K with 2SDCM binning
- >50,000 hours L70 (rated life at 70% output)

### ELECTRICAL SYSTEM

- (Non-IC) Dedicated voltage options of 120V or 277V. Must be specified in catalog code.
- (-IC) Universal 120V/277V input; Power factor >.9 50/60Hz
- This product complies with IEEE C62.41 for surge endurance up to 2.5KV. Additional surge protection recommended. Damage from power surge is not covered by warranty.

### DIMMING

- 0-10V Dimming 1%
- Forward/reverse dimming 1% (120V only)
- EldoLED 0-10V 0.1% or 1%
- Lutron® LDE1 Hi-Lume 1% EcoSystem LED driver with Soft-on, Fade-to-Black dimming technology
- DMX512 RDM 0.1%

### HOUSING

- Heavy duty black powder coated 18 gauge steel frame
- Standard housing accommodates 5/8" ceiling thickness
- Extended collar options available for ceilings up to 1" or 2" thick, must specify either EC1 or EC2

### TRIM SPECIFICATION

Aiming with locking 35° vertical and 360° horizontal adjustment. High quality trims are die-cast using A380 aluminum with durable powder coat available in multiple finishes, black interior standard. Perforated mesh frame is die-cast to a 0.8mm thickness to easily adhere to joint compound for seamless and trimless mounting. Trim is available with solite, clear tempered or frosted lens, must specify.

### INSTALLATION

Housing types include IC Air-Tight or Non-IC Rated (must specify). Non-IC rated housings must be kept at a minimum of 3" away from insulation. Butterfly brackets are compatible with adjustable bar hangers (14"-25") and EMT. Bar hangers must be ordered separately. Max. ambient temperature: 95°F (35°C).

### EMERGENCY BACKUP

Remote test switch included. External battery operates LED load at a minimum of 300 to 525 lumens for 90 minutes, depending on backup wattage selected. See trim multipliers for detailed performance. Servicing requires above ceiling access.

### LISTING / WARRANTY

- 5-Year Intense LED Limited Warranty
- ETL listed to US and Canadian standards for wet locations
- (-IC Only) Air-Tight Certified ASTM E283
- (-IC Only) ETL listed for direct contact w/insulation

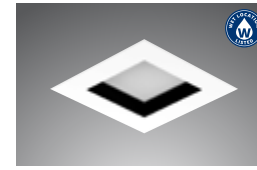

MXTG2-STLR308  
(1/2" Regress with Lens)

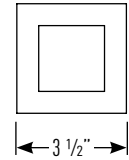
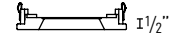

Housing dimensions are on Page 2

### Available Trim Finishes



### Housing Part Number (Example: MXG2ASTL-ICL1)

Housing	Installation Type	Ceiling Thickness	Wattage	Dimming	Voltage	Options
MXG2ASTL	-NC (Non-IC)	blank (5/8")	L0 (10W)	blank (Non-Dimming)	blank (Non-IC: 120V	I100 (C-Channel Bar Hangers)
	-IC (Air-Tight IC)	EC1 (1")	L1 (16W)	DELV <sup>2</sup> (Phase Dimming)	-IC: 120V/277V)	I200 (Flat Bar Hangers)
		EC2 (2")	L2 (20W)	D101 (0-10V Dimming 1%)	27 (277V Non-IC Only, for -IC housing options use blank)	I400 (Wood Joist Bar Hangers)
			L3 <sup>1</sup> (26W)	ED10V1 <sup>3</sup> (eldoLED 0-10V 1%)		EM7 <sup>6</sup> (7W Emergency Backup IOTA Part #ILB-CP07-A)
				ED10V01 <sup>3</sup> (eldoLED 0-10V 0.1%)		EM12 <sup>6,7</sup> (12W Emergency Backup IOTA Part #ILB-CP12-A)
		LUT <sup>4</sup> (Lutron® LDE1 EcoSystem 1%)				
			DMXR <sup>5</sup> (DMX512 RDM 0.1%)			

### Trim Part Number (Example: MXTG2-STLR308WL13024-SL)

Trim	Finish	Wattage	CCT / CRI	Optic	Lens
MXTG2-STLR308 (1/2" Regress)	W (White)	L0 (10W)	27 (2700K / 82 CRI)	09° (9° Narrow Spot)	-SL (Solite)
	B (Black)	L1 (16W)	279 (2700K / 92 CRI)	12 (12° Spot)	-CR (Clear Tempered)
		L2 (20W)	30 (3000K / 82 CRI)	24 (24° Narrow Flood)	-FR (Frosted)
	AB (Antique Bronze)	L3 (26W)	309 (3000K / 92 CRI)	36 (36° Flood)	
			35 (3500K / 82 CRI)	50 (50° Wide Flood)	
			359 (3500K / 92 CRI)		
			41 (4100K / 82 CRI)		
			419 (4100K / 92 CRI)		

### Notes:

- L3 available with Non-IC housings only
- Available in 120V only
- Not Available in L3
- Not Available in L2 & L3
- DMX512 RDM not available in L0 & L1
- Access above ceiling required
- Not available in L0
- 9° NS available in 279 with L0 or L1 Only

# MXG2ASTL

3.5" MX G2 LED Square Trimless Lensed Pinhole - Wet Location

JOB NAME		CATALOG NUMBER	
NOTES		TYPE	

## NON-IC & AIR TIGHT IC DIMENSIONS

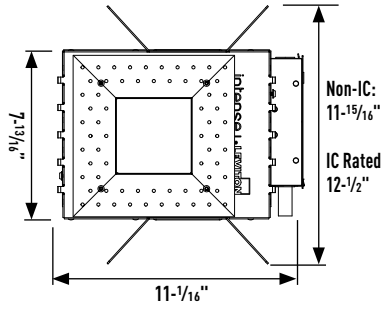
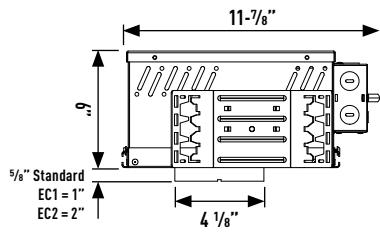

Ceiling Cut Out: 4 1/8"

## Plaster Frame Accommodation

Collar Type	Standard	EC1	EC2
Max Ceiling Thickness	Up-to 5/8"	Up-to 1"	Up-to 2"

## Fixture Aiming - Horizontal Adjustment

1/2" Regress Trims	Full 360°	Full 360°	Full 360°

## OPTICS REPLACEMENT

1. Rotate release cap by turning counter clockwise.
2. Install accessories into accessory holder and replace accessory holder's retaining clip.
3. Place accessory holder and accessory flush against optic and replace release cap.

### Optics

- IP-OP4712 (12° Spot)
- IP-OP4724 (24° Narrow Flood)
- IP-OP4736 (36° Flood)
- IP-OP4750 (50° Wide Flood)

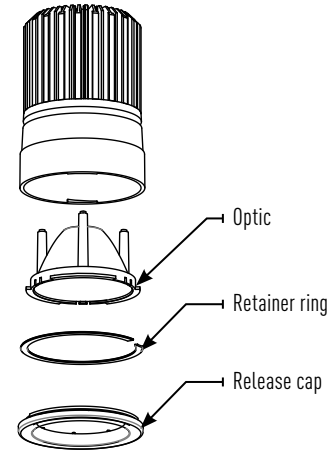

JOB NAME		CATALOG NUMBER	
NOTES		TYPE	

## MXTG2-STLR308WLO-CR

Report #:  
 ILL-02122016-11.3 (12)  
 ILL-02122016-10.3 (24)  
 ILL-02162016-02.3 (36)  
 ILL-02122016-06.3 (50)

**MXTG2-STLR308**  
 Ceiling Thickness Multipliers:  
 5/8" Thickness (x 1.00)  
 1" Thickness (x 0.78)  
 2" Thickness (x 0.56)

### CCT MULTIPLIERS:

	<b>82 CRI</b>	<b>92 CRI</b>
2700K	(x 0.93)	(x 0.76)
3000K	(x 1.00)	(x 0.87)
3500K	(x 1.00)	(x 0.87)
4100K	(x 1.00)	(x 0.87)

### LENS MULTIPLIERS:

Solite	(x 0.92)
Clear	(x 1.00)
Frosted	(x 0.92)

### EMERGENCY MULTIPLIER:

7W Emergency	(x 0.70)
--------------	----------

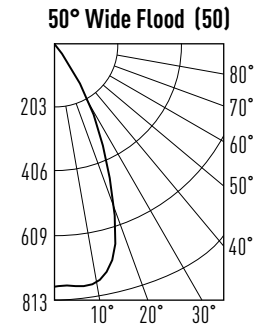
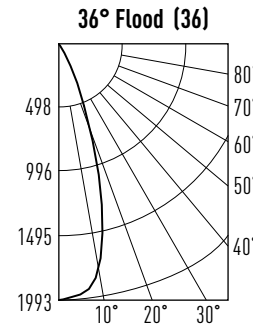
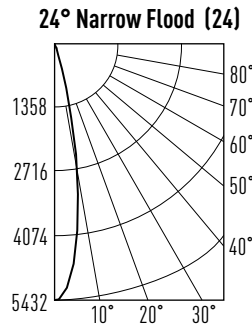
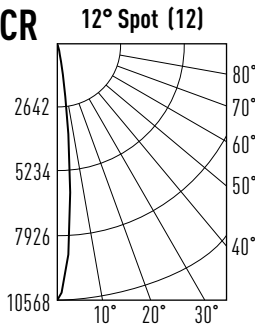

Watts: 10  
 Lumens: 564  
 LPW: 56  
 CCT: 3000K

Watts: 10  
 Lumens: 694  
 LPW: 69  
 CCT: 3000K

Watts: 10  
 Lumens: 668  
 LPW: 67  
 CCT: 3000K

Watts: 10  
 Lumens: 560  
 LPW: 56  
 CCT: 3000K

### Candelas at Nadir

Degree	Candela
0°	10568
5°	6143
15°	454
25°	42
35°	9
45°	2

### Candelas at Nadir

Degree	Candela
0°	5432
5°	4684
15°	971
25°	47
35°	4
45°	1

### Candelas at Nadir

Degree	Candela
0°	1993
5°	1959
15°	1293
25°	369
35°	53
45°	1

### Candelas at Nadir

Degree	Candela
0°	761
5°	761
15°	702
25°	371
35°	99
45°	4

### APPLICATION DATA:

**W** and **L** are the outer points where the candle power drops to 50% of maximum. **FC** are the initial footcandles at the center of the beam.

**W** Beam width  
**L** Beam length  
**C** Distance to center of beam  
**D** Distance  
**FC** Footcandles

Illuminated width & length are based upon point at which illuminance falls to 50% of center illuminance. Recommended spacing is based upon uniform illuminance aiming angle is the angle between the lamp axis and the perpendicular to the illuminated plane.

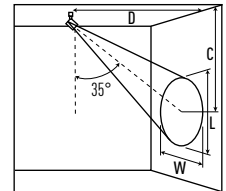
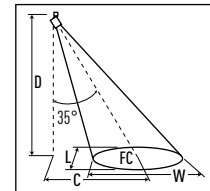
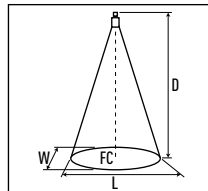

	0° HORIZONTAL				35° HORIZONTAL				35° VERTICAL					
	D	FC	W	L	D	C	FC	W	L	D	C	FC	W	L
<b>MXTG2-STLR308WLO-CR</b> 3000K 12° Spot	6'	294	1.4	1.1	6'	4	167	1.93	1.28	3'	4	307	1.06	2.13
	8'	165	1.8	1.4	8'	5	94.2	1.59	2.61	4'	6	167	1.28	2.94
	10'	106	2.3	1.8	10'	7	58.1	3.37	2.19	5'	7	114	1.48	3.42
	12'	73.4	2.8	2.1	12'	8	41.7	3.87	2.62	6'	8	76.7	1.84	4.19
<b>MXTG2-STLR308WLO-CR</b> 3000K 24° Narrow Flood	6'	151	2.2	1.9	6'	4	85.3	3.07	2.34	3'	4	170	1.49	2.95
	8'	84.9	2.9	2.6	8'	5	48.6	4.01	2.99	4'	5	95.5	2.08	3.88
	10'	54.3	3.7	3.2	10'	6	30.7	5.04	3.76	5'	7	59.7	2.76	4.9
	12'	37.7	4.4	3.9	12'	8	21.3	6.05	4.57	6'	8	42.5	3.17	5.73
<b>MXTG2-STLR308WLO-CR</b> 3000K 36° Flood	6'	55.4	3.9	3.2	6'	3	36.8	4.44	3.13	3'	3	69.6	2.33	4
	8'	31.1	5.2	4.2	8'	4	20.7	5.89	4.27	4'	4	39.1	3.04	5.44
	10'	19.9	6.5	5.3	10'	5	13.3	7.38	5.35	5'	5	25.1	3.77	6.77
	12'	13.8	7.8	6.3	12'	6	9.2	8.81	6.45	6'	7	17.4	4.57	8.09
<b>MXTG2-STLR308WLO-CR</b> 3000K 50° Wide Flood	6'	21.1	5.6	5.1	6'	2	18.1	4.6	4.89	3'	3	29.7	3.6	4.69
	8'	11.9	7.4	6.9	8'	3	10.2	6.13	6.49	4'	4	16.7	4.88	6.2
	10'	7.6	9.3	8.6	10'	4	6.4	7.76	8.11	5'	5	10.7	6.16	7.74
	12'	5.3	11.2	10.3	12'	4	4.5	9.27	9.67	6'	6	7.4	7.35	9.32

JOB NAME		CATALOG NUMBER	
NOTES		TYPE	

## MXTG2-STLR308WL1-CR

Report #: ILL-02122016-11.2 (12)  
 ILL-02122016-10.2 (24)  
 ILL-02162016-02.2 (36)  
 ILL-02122016-06.2 (50)

**MXTG2-STLR308**  
 Ceiling Thickness Multipliers:  
 5/8" Thickness (x 1.00)  
 1" Thickness (x 0.78)  
 2" Thickness (x 0.56)

### CCT MULTIPLIERS:

	<b>82 CRI</b>	<b>92 CRI</b>
2700K	(x 0.93)	(x 0.76)
3000K	(x 1.00)	(x 0.87)
3500K	(x 1.00)	(x 0.87)
4100K	(x 1.00)	(x 0.87)

### LENS MULTIPLIERS:

Solite	(x 0.92)
Clear	(x 1.00)
Frosted	(x 0.92)

### EMERGENCY MULTIPLIER:

7W Emergency	(x 0.50)
12W Emergency	(x 0.85)

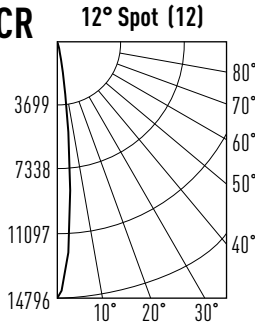

Watts: 15.4  
 Lumens: 790  
 LPW: 51  
 CCT: 3000K

### Candelas at Nadir

Degree	Candela
0°	14796
5°	8600
15°	636
25°	58
35°	13
45°	2

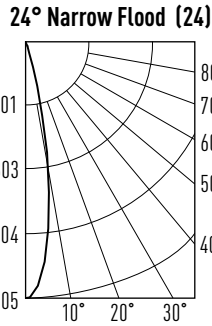

Watts: 15.4  
 Lumens: 971  
 LPW: 63  
 CCT: 3000K

### Candelas at Nadir

Degree	Candela
0°	7605
5°	6557
15°	1360
25°	65
35°	6
45°	1

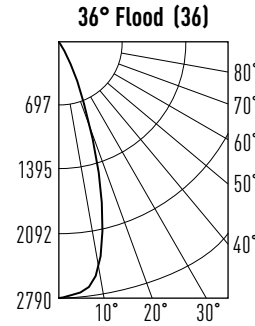

Watts: 15.4  
 Lumens: 935  
 LPW: 61  
 CCT: 3000K

### Candelas at Nadir

Degree	Candela
0°	2790
5°	2743
15°	1811
25°	516
35°	74
45°	1

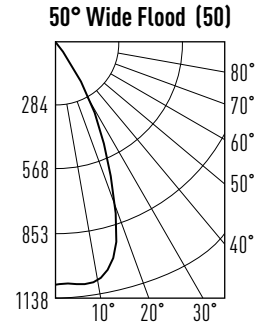

Watts: 15.4  
 Lumens: 783  
 LPW: 51  
 CCT: 3000K

### Candelas at Nadir

Degree	Candela
0°	1066
5°	1066
15°	983
25°	520
35°	139
45°	5

### APPLICATION DATA:

**W** and **L** are the outer points where the candle power drops to 50% of maximum. **FC** are the initial footcandles at the center of the beam.

- W** Beam width
- L** Beam length
- C** Distance to center of beam
- D** Distance
- FC** Footcandles

Illuminated width & length are based upon point at which illuminance falls to 50% of center illuminance. Recommended spacing is based upon uniform illuminance aiming angle is the angle between the lamp axis and the perpendicular to the illuminated plane.

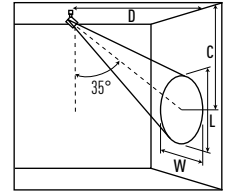
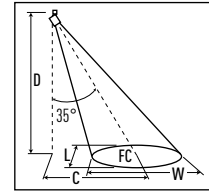
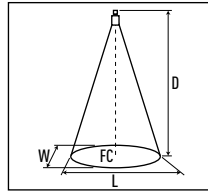

	0° HORIZONTAL				35° HORIZONTAL				35° VERTICAL					
	D	FC	W	L	D	C	FC	W	L	D	C	FC	W	L
<b>MXTG2-STLR308WL1-CR</b> <b>3000K</b> <b>12° Spot</b>	6'	411	1.4	1.1	6'	4	234	1.93	1.28	3'	4	429	1.06	2.13
	8'	231	1.8	1.4	8'	5	132	1.59	2.61	4'	6	234	1.28	2.94
	10'	148	2.3	1.8	10'	7	81.4	3.37	2.19	5'	7	160	1.48	3.42
	12'	103	2.8	2.1	12'	8	58.4	3.87	2.62	6'	8	107	1.84	4.19
<b>MXTG2-STLR308WL1-CR</b> <b>3000K</b> <b>24° Narrow Flood</b>	6'	211	2.2	1.9	6'	4	119	3.07	2.34	3'	4	238	1.49	2.95
	8'	119	2.9	2.6	8'	5	68.1	4.01	2.99	4'	5	134	2.08	3.88
	10'	76.1	3.7	3.2	10'	6	42.9	5.04	3.76	5'	7	83.6	2.76	4.9
	12'	52.8	4.4	3.9	12'	8	29.8	6.05	4.57	6'	8	59.5	3.17	5.73
<b>MXTG2-STLR308WL1-CR</b> <b>3000K</b> <b>36° Flood</b>	6'	77.5	3.9	3.2	6'	3	51.6	4.44	3.13	3'	3	97.4	2.33	4
	8'	43.6	5.2	4.2	8'	4	29	5.89	4.27	4'	4	54.8	3.04	5.44
	10'	27.9	6.5	5.3	10'	5	18.6	7.38	5.35	5'	5	35.1	3.77	6.77
	12'	19.4	7.8	6.3	12'	6	12.9	8.81	6.45	6'	7	24.4	4.57	8.09
<b>MXTG2-STLR308WL1-CR</b> <b>3000K</b> <b>50° Wide Flood</b>	6'	29.6	5.6	5.1	6'	2	25.4	4.6	4.89	3'	3	41.6	3.6	4.69
	8'	16.7	7.4	6.9	8'	3	14.3	6.13	6.49	4'	4	23.4	4.88	6.2
	10'	10.7	9.3	8.6	10'	4	9	7.76	8.11	5'	5	15	6.16	7.74
	12'	7.4	11.2	10.3	12'	4	6.3	9.27	9.67	6'	6	10.4	7.35	9.32

JOB NAME		CATALOG NUMBER	
NOTES		TYPE	

## MXTG2-STLR308WL2-CR

Report #:  
 ILL-02122016-11.1 (12)  
 ILL-02122016-10.1 (24)  
 ILL-02162016-02.1 (36)  
 ILL-02122016-06.1 (50)

**MXTG2-STLR308**  
 Ceiling Thickness Multipliers:  
 5/8" Thickness (x 1.00)  
 1" Thickness (x 0.78)  
 2" Thickness (x 0.56)

### CCT MULTIPLIERS:

	<b>82 CRI</b>	<b>92 CRI</b>
2700K	(x 0.93)	(x 0.76)
3000K	(x 1.00)	(x 0.87)
3500K	(x 1.00)	(x 0.87)
4100K	(x 1.00)	(x 0.87)

### LENS MULTIPLIERS:

Solite	(x 0.92)
Clear	(x 1.00)
Frosted	(x 0.92)

### EMERGENCY MULTIPLIER:

7W Emergency	(x 0.40)
12W Emergency	(x 0.68)

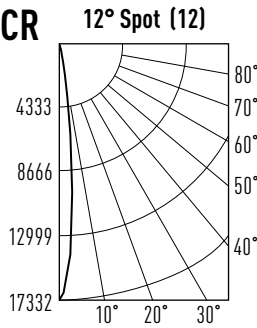

Watts: 20.5  
 Lumens: 925  
 LPW: 45  
 CCT: 3000K

### Candelas at Nadir

Degree	Candela
0°	17332
5°	10074
15°	745
25°	68
35°	15
45°	2

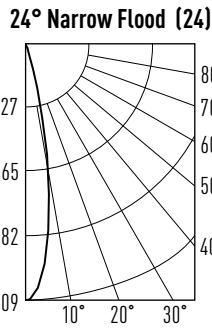

Watts: 20.4  
 Lumens: 1138  
 LPW: 56  
 CCT: 3000K

### Candelas at Nadir

Degree	Candela
0°	8909
5°	7681
15°	1593
25°	76
35°	7
45°	1

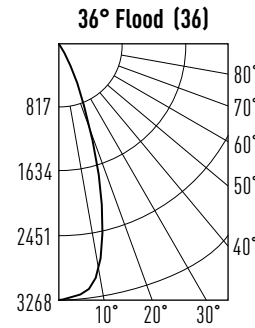

Watts: 20.5  
 Lumens: 1095  
 LPW: 53  
 CCT: 3000K

### Candelas at Nadir

Degree	Candela
0°	3268
5°	3214
15°	2121
25°	604
35°	87
45°	1

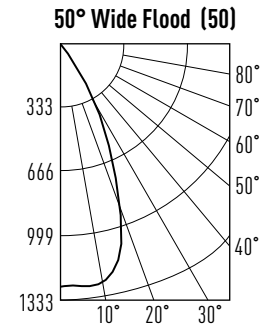

Watts: 20.5  
 Lumens: 918  
 LPW: 45  
 CCT: 3000K

### Candelas at Nadir

Degree	Candela
0°	1248
5°	1249
15°	1151
25°	609
35°	163
45°	6

### APPLICATION DATA:

**W** and **L** are the outer points where the candle power drops to 50% of maximum. **FC** are the initial footcandles at the center of the beam.

- W** Beam width
- L** Beam length
- C** Distance to center of beam
- D** Distance
- FC** Footcandles

Illuminated width & length are based upon point at which illuminance falls to 50% of center illuminance. Recommended spacing is based upon uniform illuminance aiming angle is the angle between the lamp axis and the perpendicular to the illuminated plane.

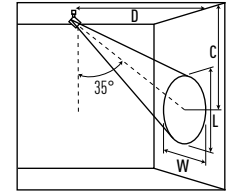
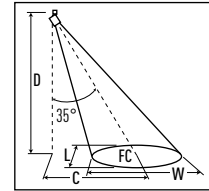
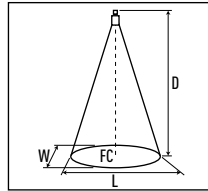

	0° HORIZONTAL				35° HORIZONTAL				35° VERTICAL					
	D	FC	W	L	D	C	FC	W	L	D	C	FC	W	L
<b>MXTG2-STLR308WL2-CR</b> <b>3000K</b> <b>12° Spot</b>	6'	481	1.4	1.1	6'	4	274	1.93	1.28	3'	4	503	1.06	2.13
	8'	271	1.8	1.4	8'	5	155	1.59	2.61	4'	6	274	1.28	2.94
	10'	173	2.3	1.8	10'	7	95.3	3.37	2.19	5'	7	188	1.48	3.42
	12'	120	2.8	2.1	12'	8	68.4	3.87	2.62	6'	8	126	1.84	4.19
<b>MXTG2-STLR308WL2-CR</b> <b>3000K</b> <b>24° Narrow Flood</b>	6'	247	2.2	1.9	6'	4	140	3.07	2.34	3'	4	279	1.49	2.95
	8'	139	2.9	2.6	8'	5	79.7	4.01	2.99	4'	5	157	2.08	3.88
	10'	89.1	3.7	3.2	10'	6	50.3	5.04	3.76	5'	7	97.9	2.76	4.9
	12'	61.9	4.4	3.9	12'	8	35	6.05	4.57	6'	8	69.7	3.17	5.73
<b>MXTG2-STLR308WL2-CR</b> <b>3000K</b> <b>36° Flood</b>	6'	90.8	3.9	3.2	6'	3	60.4	4.44	3.13	3'	3	114	2.33	4
	8'	51.1	5.2	4.2	8'	4	34	5.89	4.27	4'	4	64.2	3.04	5.44
	10'	32.7	6.5	5.3	10'	5	21.7	7.38	5.35	5'	5	41.1	3.77	6.77
	12'	22.7	7.8	6.3	12'	6	15.1	8.81	6.45	6'	7	28.5	4.57	8.09
<b>MXTG2-STLR308WL2-CR</b> <b>3000K</b> <b>50° Wide Flood</b>	6'	34.7	5.6	5.1	6'	2	29.7	4.6	4.89	3'	3	48.8	3.6	4.69
	8'	19.5	7.4	6.9	8'	3	16.7	6.13	6.49	4'	4	27.4	4.88	6.2
	10'	12.5	9.3	8.6	10'	4	10.96	7.76	8.11	5'	5	17.6	6.16	7.74
	12'	8.7	11.2	10.3	12'	4	7.4	9.27	9.67	6'	6	12.2	7.35	9.32

JOB NAME		CATALOG NUMBER	
NOTES		TYPE	

## MXTG2-STLR308WL3-CR

Report #: ILL-02122016-11 (12)  
 ILL-02122016-10 (24)  
 ILL-02162016-02 (36)  
 ILL-02122016-06 (50)

**MXTG2-STLR308**  
 Ceiling Thickness Multipliers:  
 5/8" Thickness (x 1.00)  
 1" Thickness (x 0.78)  
 2" Thickness (x 0.56)

### CCT MULTIPLIERS:

	<b>82 CRI</b>	<b>92 CRI</b>
2700K	(x 0.93)	(x 0.76)
3000K	(x 1.00)	(x 0.87)
3500K	(x 1.00)	(x 0.87)
4100K	(x 1.00)	(x 0.87)

### LENS MULTIPLIERS:

Solite	(x 0.92)
Clear	(x 1.00)
Frosted	(x 0.92)

### EMERGENCY MULTIPLIER:

7W Emergency	(x 0.35)
12W Emergency	(x 0.59)

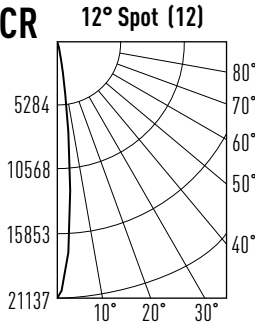

Watts: 25.7  
 Lumens: 1128  
 LPW: 43  
 CCT: 3000K

### Candelas at Nadir

Degree	Candela
0°	21137
5°	12285
15°	908
25°	83
35°	18
45°	3

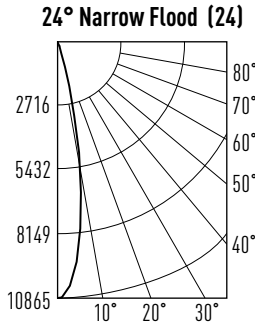

Watts: 25.7  
 Lumens: 1387  
 LPW: 58  
 CCT: 3000K

### Candelas at Nadir

Degree	Candela
0°	10865
5°	9367
15°	1943
25°	93
35°	8
45°	1

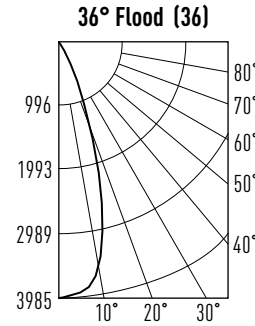

Watts: 26  
 Lumens: 1336  
 LPW: 53  
 CCT: 3000K

### Candelas at Nadir

Degree	Candela
0°	3985
5°	3919
15°	2587
25°	737
35°	106
45°	2

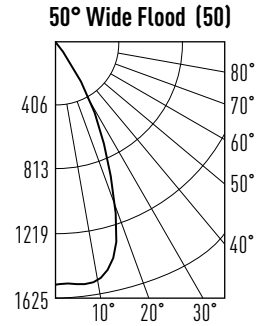

Watts: 26.1  
 Lumens: 1119  
 LPW: 43  
 CCT: 3000K

### Candelas at Nadir

Degree	Candela
0°	1523
5°	1523
15°	1404
25°	743
35°	199
45°	7

### APPLICATION DATA:

**W** and **L** are the outer points where the candle power drops to 50% of maximum. **FC** are the initial footcandles at the center of the beam.

**W** Beam width  
**L** Beam length  
**C** Distance to center of beam  
**D** Distance  
**FC** Footcandles

Illuminated width & length are based upon point at which illuminance falls to 50% of center illuminance. Recommended spacing is based upon uniform illuminance aiming angle is the angle between the lamp axis and the perpendicular to the illuminated plane.

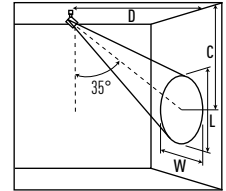
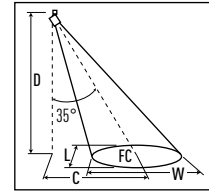
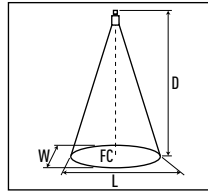

	0° HORIZONTAL				35° HORIZONTAL				35° VERTICAL					
	D	FC	W	L	D	C	FC	W	L	D	C	FC	W	L
<b>MXTG2-STLR308WL3-CR</b> 3000K 12° Spot	6'	587	1.4	1.1	6'	4	334	1.93	1.28	3'	4	614	1.06	2.13
	8'	330	1.8	1.4	8'	5	188	1.59	2.61	4'	6	334	1.28	2.94
	10'	211	2.3	1.8	10'	7	116	3.37	2.19	5'	7	229	1.48	3.42
	12'	147	2.8	2.1	12'	8	83.4	3.87	2.62	6'	8	153	1.84	4.19
<b>MXTG2-STLR308WL3-CR</b> 3000K 24° Narrow Flood	6'	302	2.2	1.9	6'	4	171	3.07	2.34	3'	4	340	1.49	2.95
	8'	170	2.9	2.6	8'	5	97.2	4.01	2.99	4'	5	191	2.08	3.88
	10'	109	3.7	3.2	10'	6	61.3	5.04	3.76	5'	7	119	2.76	4.9
	12'	75.5	4.4	3.9	12'	8	42.6	6.05	4.57	6'	8	85	3.17	5.73
<b>MXTG2-STLR308WL3-CR</b> 3000K 36° Flood	6'	111	3.9	3.2	6'	3	73.6	4.44	3.13	3'	3	139	2.33	4
	8'	62.3	5.2	4.2	8'	4	41.4	5.89	4.27	4'	4	78.3	3.04	5.44
	10'	39.9	6.5	5.3	10'	5	26.5	7.38	5.35	5'	5	50.1	3.77	6.77
	12'	27.7	7.8	6.3	12'	6	18.4	8.81	6.45	6'	7	34.8	4.57	8.09
<b>MXTG2-STLR308WL3-CR</b> 3000K 50° Wide Flood	6'	42.3	5.6	5.1	6'	2	36.2	4.6	4.89	3'	3	59.5	3.6	4.69
	8'	23.8	7.4	6.9	8'	3	20.4	6.13	6.49	4'	4	33.5	4.88	6.2
	10'	15.2	9.3	8.6	10'	4	12.9	7.76	8.11	5'	5	21.4	6.16	7.74
	12'	10.6	11.2	10.3	12'	4	9.1	9.27	9.67	6'	6	14.9	7.35	9.32