

MXG2ASTR

3.5" MX G2 LED Square Adjustable

JOB NAME		CATALOG NUMBER	
NOTES		TYPE	

ELECTRICAL DATA

LED Light Engine	System Wattage *	CCT / CRI	Delivered Lumens **	Lumens Per Watt
L0	10W	3000K / 82 CRI	900lm	90
L1	16W	3000K / 82 CRI	1250lm	78
L2	20W	3000K / 82 CRI	1450lm	73
L3	26W	3000K / 82 CRI	1800lm	69

*System Wattage include driver and LED Module consumption. **Delivered lumens will vary depending on trim, CCT, CRI, optic and ceiling thickness

FEATURES

- Multiple architectural trim options
- High center beam spot up to 24,500 CBCP
- Dedicated 9° with field changeable 12°, 24°, 36° & 50° optics

LED LIGHT ENGINE

- 92 CRI & 82 CRI in 2700K, 3000K, 3500K or 4100K with 2SDCM binning
- >50,000 hours L70 (rated life at 70% output)

ELECTRICAL SYSTEM

- (Non-IC) Dedicated voltage options of 120V or 277V. Must be specified in catalog code.
- (-IC) Universal 120V/277V input; Power factor >.9 50/60Hz
- This product complies with IEEE C62.41 for surge endurance up to 2.5KV. Additional surge protection recommended. Damage from power surge is not covered by warranty.

DIMMING

- 0-10V Dimming 1%
- Forward/reverse dimming 1% (120V only)
- EldoLED 0-10V 0.1% or 1%
- Lutron® LDE1 Hi-Lume 1% EcoSystem LED driver with Soft-on, Fade-to-Black dimming technology
- DMX512 RDM 0.1%

HOUSING

- Heavy duty black powder coated 18 gauge steel frame
- Standard housing accommodates 5/8" ceiling thickness
- Extended collar options available for ceilings up to 1" or 2" thick, must specify either EC1 or EC2 (EC1/EC2)

INSTALLATION

Housing types include IC Air-Tight or Non-IC Rated (must specify). Non-IC rated housings must be kept at a minimum of 3" away from insulation. Butterfly brackets are compatible with C-channel, adjustable bar hangers (14"-25") and EMT. C-channel is recommended for T-bar ceilings. Bar hangers must be ordered separately. Max. ambient temperature: 95°F (35°C).

EMERGENCY BACKUP

Remote test switch included. External battery operates LED load at a minimum of 500 to 850 lumens for 90 minutes, depending on backup wattage selected. See trim multipliers for detailed performance. Servicing requires above ceiling access.

TRIM SPECIFICATION

Aiming with locking 35° vertical and 360° horizontal adjustment with 1/2" regress and 90° turns (90, 180, 270 and 360) with 1" regress for greater visual comfort. See fixture aiming chart on page 2. High quality trims are die-cast using A380 aluminum with durable powder coat available in multiple finishes. Architectural, discrete self flange or painted white flange options available. Trims available in 1" regress for greater visual comfort or 1/2" regress for consistent look throughout space.

LISTING / WARRANTY

- 5-Year Intense LED Limited Warranty
- ETL listed to US and Canadian standards for damp locations
- (-IC Only) Air-Tight Certified ASTM E283
- (-IC Only) ETL listed for direct contact w/insulation
- ENERGY STAR® Qualified ¹
- Can be used to comply with 2016 Title 24, Part 6, JA8 high efficacy LED light source requirements ²

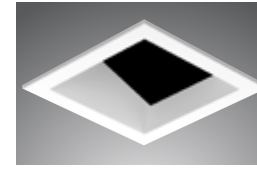

MXTG2-STRA300
(1" Regress)

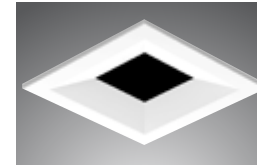
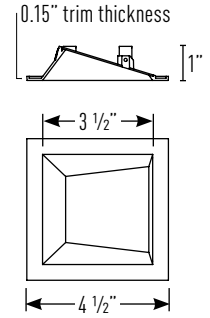

MXTG2-STRR300
(1/2" Regress)

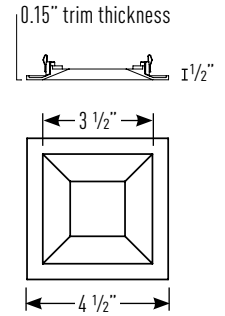

Housing dimensions are on Page 2

Available Trim Finishes

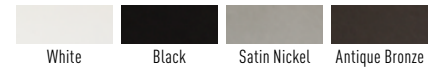

Housing Part Number (Example: MXG2ASTR-ICL1)

Housing	Installation Type	Ceiling Thickness	Wattage	Dimming	Voltage	Options
MXG2ASTR	-NC (Non-IC)	blank (5/8")	L0 (10W)	blank (Non-Dimming)	blank (Non-IC: 120V	1100 (C-Channel Bar Hangers)
	-IC (Air-Tight IC)	EC1 (1")	L1 (16W)	DELV ⁴ (Phase Dimming)	-IC: 120V/277V)	1200 (Flat Bar Hangers)
		EC2 (2")	L2 (20W)	D101 (0-10V Dimming 1%)	27 (277V Non-IC Only, for	1400 (Wood Joist Bar Hangers)
			L3 ³ (26W)	ED10V1 ⁵ (eldoLED 0-10V 1%)	-IC housing options use blank)	-EM7 ⁸ (7W Emergency Backup IOTA Part #ILB-CP07-A)
			ED10V01 ⁵ (eldoLED 0-10V 0.1%)		-EM12 ^{8,9} (12W Emergency Backup IOTA Part #ILB-CP12-A)	
			LUT ⁶ (Lutron® LDE1 EcoSystem 1%)			
			DMXR ⁷ (DMX512 RDM 0.1%)			

Trim Part Number (Example: MXTG2-STRA300W-SFL13024)

Trim	Finish	Wattage	CCT / CRI	Optic
MXTG2-STRA300 (1" Regress)	W-SF (White / Self Flanged)	L0 (10W)	27 (2700K / 82 CRI)	09 ¹¹ (9° Narrow Spot)
	B-SF (Black / Self Flanged)	L1 (16W)	279 (2700K / 92 CRI)	12 (12° Spot)
MXTG2-STRR300 (1/2" Regress)	SN-SF (Satin Nickel / Self Flanged)	L2 (20W)	30 (3000K / 82 CRI)	24 (24° Narrow Flood)
	SN-SFW ¹⁰ (Satin Nickel / Self Flanged White)	L3 ³ (26W)	309 (3000K / 92 CRI)	36 (36° Flood)
	AB-SF (Antique Bronze / Self Flanged)		35 (3500K / 82 CRI)	50 (50° Wide Flood)
	AB-SFW ¹⁰ (Antique Bronze / Self Flanged White)		359 (3500K / 92 CRI)	
			41 (4100K / 82 CRI)	
		419 (4100K / 92 CRI)		

Notes:

- ENERGY STAR® Qualified (White reflectors only). Excludes: L2, L3, 92 CRI & 9° options
- Excludes: L2, L3, 82 CRI & 9° options
- L3 available with Non-IC housings only
- Available in 120V only
- Not Available in L3
- Not Available in L2 & L3
- DMX512 RDM not available in L0 & L1
- Access above ceiling required
- Not available in L0
- Consult factory for lead times
- 9° NS available in 279 with L0 or L1 Only

MXG2ASTR

3.5" MX G2 LED Square Adjustable

JOB NAME		CATALOG NUMBER	
NOTES		TYPE	

NON-IC & AIR TIGHT IC DIMENSIONS

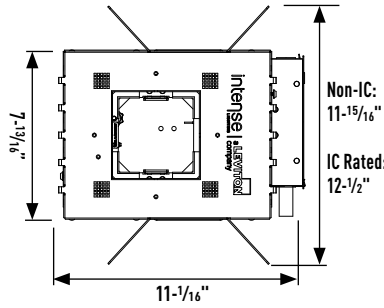
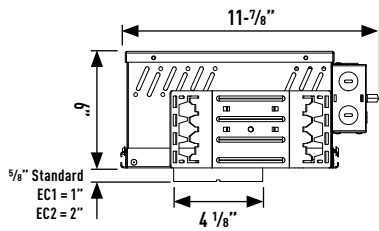

Plaster Frame Accommodation

Collar Type	Standard	EC1	EC2
Max Ceiling Thickness	Up-to 5/8"	Up-to 1"	Up-to 2"

Fixture Aiming - Horizontal Adjustment

1" Regress Trims	90° turns	90° turns	Full 360°
1/2" Regress Trims	Full 360°	Full 360°	Full 360°

Ceiling Cut Out: 4 1/8"

ACCESSORIES

Luminaire will accommodate (2) accessories, accessory holder required.

INSTALLATION

1. Rotate release cap by turning counter clockwise.
2. Install accessories into accessory holder and replace accessory holder's retaining clip.
3. Place accessory holder and accessory flush against optic and replace release cap.

Accessories

LH47	(Accessory Holder, Black)
LH47W	(Accessory Holder, White)
PFLMB-47	(Hex Louver, Black)
PFL1-47	(Prismatic Spread Lens)
PFL2-47	(Linear Spread Lens)
PFL4-47	(Soft Focus Lens)

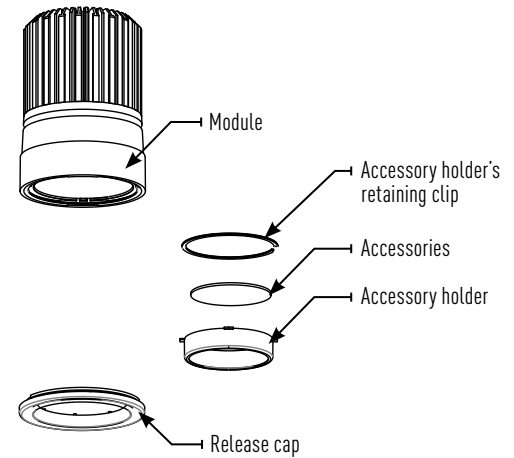

OPTICS REPLACEMENT

1. Rotate release cap by turning counter clockwise.
2. Install accessories into accessory holder and replace accessory holder's retaining clip.
3. Place accessory holder and accessory flush against optic and replace release cap.

Optics

IP-OP4712	(12° Spot)
IP-OP4724	(24° Narrow Flood)
IP-OP4736	(36° Flood)
IP-OP4750	(50° Wide Flood)

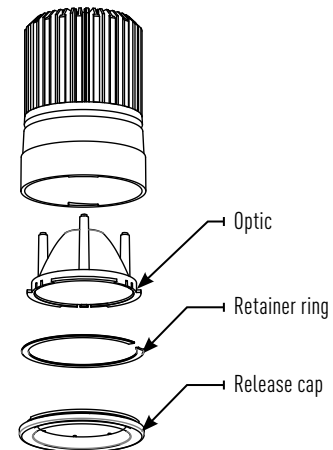

JOB NAME		CATALOG NUMBER	
NOTES		TYPE	

MXTG2-STRA300WLO

Report #: ILL-02222016-01.3 (12)
 ILL-02222016-02.3 (24)
 ILL-02222016-03.3 (36)
 ILL-02222016-04.3 (50)

MXTG2-STRA300

Ceiling Thickness Multipliers:
 5/8" Thickness (x 1.00)
 1" Thickness (x 0.86)
 2" Thickness (x 0.72)

MXTG2-STRR300

Ceiling Thickness Multipliers:
 5/8" Thickness (x 0.91)
 1" Thickness (x 0.73)
 2" Thickness (x 0.55)

CCT MULTIPLIERS:

	82 CRI	92 CRI
2700K	(x 0.93)	(x 0.76)
3000K	(x 1.00)	(x 0.87)
3500K	(x 1.00)	(x 0.87)
4100K	(x 1.00)	(x 0.87)

Emergency Multiplier:
 7W Emergency (x 0.70)

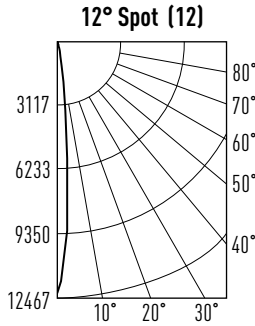

Watts: 10
 Lumens: 857
 LPW: 86
 CCT: 3000K

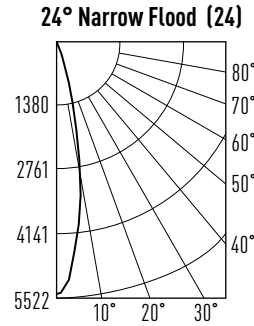

Watts: 10
 Lumens: 902
 LPW: 90
 CCT: 3000K

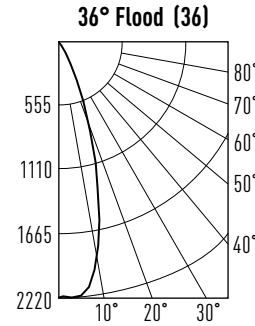

Watts: 10
 Lumens: 851
 LPW: 85
 CCT: 3000K

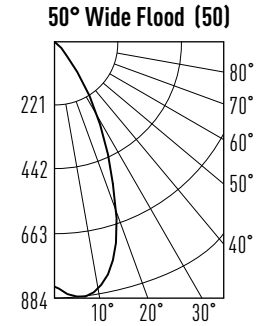

Watts: 10
 Lumens: 726
 LPW: 73
 CCT: 3000K

Candelas at Nadir

Degree	Candela
0°	12158
5°	4706
15°	428
25°	107
35°	36
45°	5

Candelas at Nadir

Degree	Candela
0°	5419
5°	4521
15°	1351
25°	165
35°	21
45°	3

Candelas at Nadir

Degree	Candela
0°	2213
5°	2205
15°	1313
25°	397
35°	80
45°	8

Candelas at Nadir

Degree	Candela
0°	844
5°	882
15°	779
25°	445
35°	180
45°	48

APPLICATION DATA:

W and **L** are the outer points where the candle power drops to 50% of maximum. **FC** are the initial foot candles at the center of the beam.

- W** Beam width
- L** Beam length
- C** Distance to center of beam
- D** Distance
- FC** Footcandles

Illuminated width & length are based upon point at which illuminance falls to 50% of center illuminance. Recommended spacing is based upon uniform illuminance aiming angle is the angle between the lamp axis and the perpendicular to the illuminated plane.

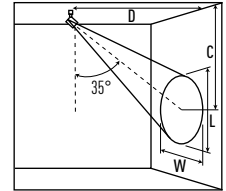
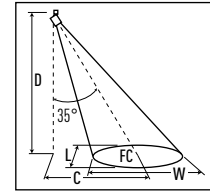
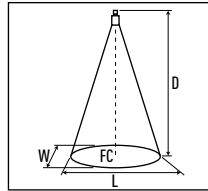

	0° HORIZONTAL				35° HORIZONTAL				35° VERTICAL					
	D	FC	W	L	D	C	FC	W	L	D	C	FC	W	L
MXTG2-STRA300WLO 3000K 12° Spot	6'	338	1.3	1.4	6'	4	198	1.98	1.49	3'	4	317	1.15	2.42
	8'	190	1.8	1.8	8'	5	118	2.58	2.1	4'	6	198	1.49	2.96
	10'	122	2.2	2.3	10'	6	74.4	3.13	2.67	5'	7	129	1.89	3.48
	12'	84.4	2.7	2.7	12'	7	51	3.82	3.19	6'	9	87.9	2.55	4.24
MXTG2-STRA300WLO 3000K 24° Narrow Flood	6'	151	2.4	2.2	6'	4	87.8	3.2	2.64	3'	4	169	1.78	3.22
	8'	84.7	3.2	3	8'	5	50.6	4.19	3.35	4'	5	93.7	2.5	4.28
	10'	54.2	4	3.7	10'	6	32.6	5.22	4.16	5'	7	59.4	3.15	5.36
	12'	37.6	4.8	4.4	12'	6	22.7	6.24	5.03	6'	8	42.2	3.65	6.31
MXTG2-STRA300WLO 3000K 36° Flood	6'	61.5	3.9	3.5	6'	3	39.4	4.6	3.63	3'	3	74.6	2.76	4
	8'	34.6	5.2	4.7	8'	4	22.1	6.16	5.01	4'	5	42.2	3.46	5.34
	10'	22.1	6.5	5.8	10'	5	14.2	7.67	6.27	5'	6	27.8	4.33	6.47
	12'	15.4	7.8	7	12'	6	9.8	9.21	7.48	6'	7	19.5	5.13	7.64
MXTG2-STRA300WLO 3000K 50° Wide Flood	6'	23.4	6.2	5.8	6'	2	17.5	5.76	5.32	3'	3	33.9	3.46	4.18
	8'	13.2	8.2	7.8	8'	3	9.8	7.76	7.19	4'	4	19.1	4.7	5.5
	10'	8.4	10.3	9.7	10'	3	6.3	9.68	8.97	5'	5	12.2	5.84	6.89
	12'	5.9	12.4	11.7	12'	4	4.4	11.51	10.67	6'	6	8.5	6.99	8.2

JOB NAME		CATALOG NUMBER	
NOTES		TYPE	

MXTG2-STRA300WL1

Report #: ILL-02222016-01.2 (12)
 ILL-02222016-02.2 (24)
 ILL-02222016-03.2 (36)
 ILL-02222016-04.2 (50)

MXTG2-STRA300

Ceiling Thickness Multipliers:
 5/8" Thickness (x 1.00)
 1" Thickness (x 0.86)
 2" Thickness (x 0.72)

MXTG2-STRR300

Ceiling Thickness Multipliers:
 5/8" Thickness (x 0.91)
 1" Thickness (x 0.73)
 2" Thickness (x 0.55)

CCT MULTIPLIERS:

	82 CRI	92 CRI
2700K	(x 0.93)	(x 0.76)
3000K	(x 1.00)	(x 0.87)
3500K	(x 1.00)	(x 0.87)
4100K	(x 1.00)	(x 0.87)

EMERGENCY MULTIPLIER:

7W Emergency (x 0.50)
 12W Emergency (x 0.85)

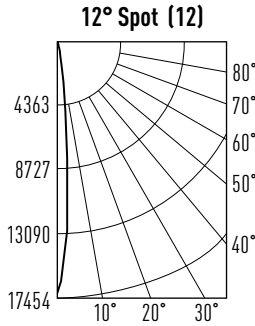

Watts: 15.4
 Lumens: 1205
 LPW: 78
 CCT: 3000K

Candelas at Nadir

Degree	Candela
0°	17021
5°	6589
15°	599
25°	150
35°	51
45°	7

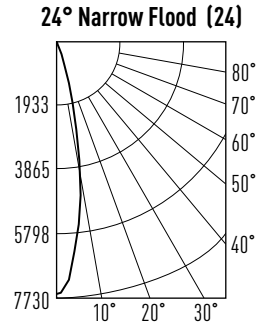

Watts: 15.5
 Lumens: 1263
 LPW: 81
 CCT: 3000K

Candelas at Nadir

Degree	Candela
0°	7586
5°	6329
15°	1892
25°	231
35°	29
45°	4

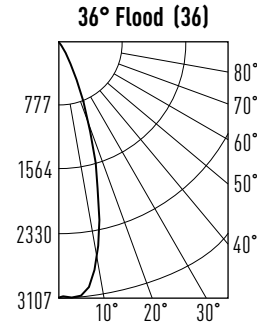

Watts: 15.5
 Lumens: 1191
 LPW: 77
 CCT: 3000K

Candelas at Nadir

Degree	Candela
0°	3098
5°	3087
15°	1838
25°	555
35°	112
45°	11

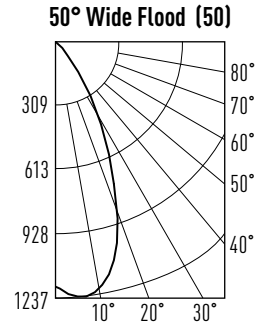

Watts: 15.5
 Lumens: 1017
 LPW: 66
 CCT: 3000K

Candelas at Nadir

Degree	Candela
0°	1181
5°	1234
15°	1091
25°	623
35°	253
45°	68

APPLICATION DATA:

W and **L** are the outer points where the candle power drops to 50% of maximum. **FC** are the initial foot candles at the center of the beam.

- W** Beam width
- L** Beam length
- C** Distance to center of beam
- D** Distance
- FC** Footcandles

Illuminated width & length are based upon point at which illuminance falls to 50% of center illuminance. Recommended spacing is based upon uniform illuminance aiming angle is the angle between the lamp axis and the perpendicular to the illuminated plane.

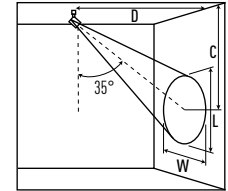
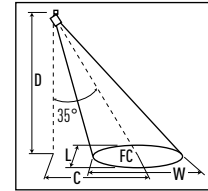
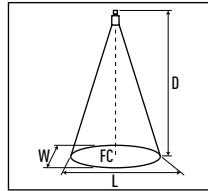

	0° HORIZONTAL				35° HORIZONTAL				35° VERTICAL					
	D	FC	W	L	D	C	FC	W	L	D	C	FC	W	L
MXTG2-STRA300WL1 3000K 12° Spot	6'	473	1.3	1.4	6'	4	277	1.98	1.49	3'	4	444	1.15	2.42
	8'	266	1.8	1.8	8'	5	165	2.58	2.1	4'	6	277	1.49	2.96
	10'	170	2.2	2.3	10'	6	104	3.13	2.67	5'	7	180	1.89	3.48
	12'	118	2.7	2.7	12'	7	71.4	3.82	3.19	6'	9	123	2.55	4.24
MXTG2-STRA300WL1 3000K 24° Narrow Flood	6'	211	2.4	2.2	6'	4	123	3.2	2.64	3'	4	236	1.78	3.22
	8'	119	3.2	3	8'	5	70.8	4.19	3.35	4'	5	131	2.5	4.28
	10'	75.9	4	3.7	10'	6	45.7	5.22	4.16	5'	7	83.1	3.15	5.36
	12'	52.7	4.8	4.4	12'	6	31.8	6.24	5.03	6'	8	59	3.65	6.31
MXTG2-STRA300WL1 3000K 36° Flood	6'	86	3.9	3.5	6'	3	55.1	4.6	3.63	3'	3	104	2.76	4
	8'	48.4	5.2	4.7	8'	4	31	6.16	5.01	4'	5	59.1	3.46	5.34
	10'	31	6.5	5.8	10'	5	19.8	7.67	6.27	5'	6	38.9	4.33	6.47
	12'	21.5	7.8	7	12'	6	13.8	9.21	7.48	6'	7	27.3	5.13	7.64
MXTG2-STRA300WL1 3000K 50° Wide Flood	6'	32.8	6.2	5.8	6'	2	24.5	5.76	5.32	3'	3	47.5	3.46	4.18
	8'	18.5	8.2	7.8	8'	3	13.7	7.76	7.19	4'	4	26.7	4.7	5.5
	10'	11.8	10.3	9.7	10'	3	8.8	9.68	8.97	5'	5	17.1	5.84	6.89
	12'	8.2	12.4	11.7	12'	4	6.1	11.51	10.67	6'	6	11.9	6.99	8.2

JOB NAME		CATALOG NUMBER	
NOTES		TYPE	

MXTG2-STRA300WL2

Report #: ILL-02222016-01.1 (12)
 ILL-02222016-02.1 (24)
 ILL-02222016-03.1 (36)
 ILL-02222016-04.1 (50)

MXTG2-STRA300
 Ceiling Thickness Multipliers:
 5/8" Thickness (x 1.00)
 1" Thickness (x 0.86)
 2" Thickness (x 0.72)

MXTG2-STRR300
 Ceiling Thickness Multipliers:
 5/8" Thickness (x 0.91)
 1" Thickness (x 0.73)
 2" Thickness (x 0.55)

CCT MULTIPLIERS:

	82 CRI	92 CRI
2700K	(x 0.93)	(x 0.76)
3000K	(x 1.00)	(x 0.87)
3500K	(x 1.00)	(x 0.87)
4100K	(x 1.00)	(x 0.87)

EMERGENCY MULTIPLIER:

7W Emergency	(x 0.40)
12W Emergency	(x 0.68)

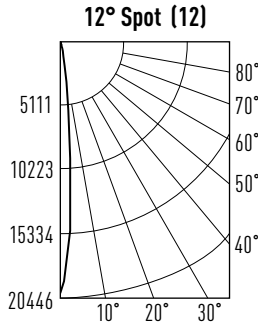

Watts: 20.5
 Lumens: 1406
 LPW: 69
 CCT: 3000K

Candelas at Nadir

Degree	Candela
0°	19939
5°	7718
15°	702
25°	175
35°	59
45°	8

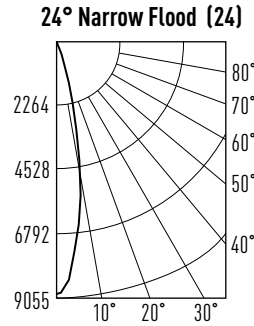

Watts: 20.4
 Lumens: 1480
 LPW: 73
 CCT: 3000K

Candelas at Nadir

Degree	Candela
0°	8887
5°	7415
15°	2216
25°	271
35°	34
45°	4

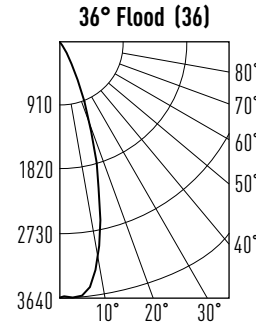

Watts: 20.5
 Lumens: 1395
 LPW: 68
 CCT: 3000K

Candelas at Nadir

Degree	Candela
0°	3629
5°	3617
15°	2153
25°	651
35°	131
45°	12

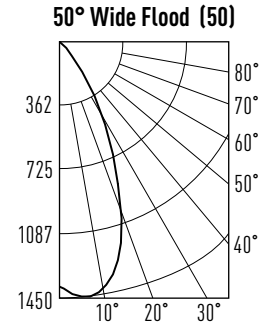

Watts: 20.4
 Lumens: 1191
 LPW: 58
 CCT: 3000K

Candelas at Nadir

Degree	Candela
0°	1384
5°	1446
15°	1278
25°	730
35°	296
45°	79

APPLICATION DATA:

W and **L** are the outer points where the candle power drops to 50% of maximum. **FC** are the initial footcandles at the center of the beam.

- W** Beam width
- L** Beam length
- C** Distance to center of beam
- D** Distance
- FC** Footcandles

Illuminated width & length are based upon point at which illuminance falls to 50% of center illuminance. Recommended spacing is based upon uniform illuminance aiming angle is the angle between the lamp axis and the perpendicular to the illuminated plane.

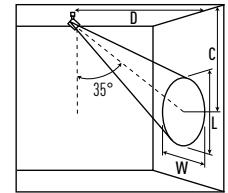
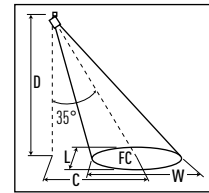
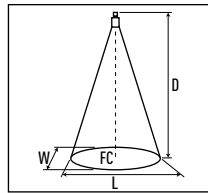

	0° HORIZONTAL				35° HORIZONTAL				35° VERTICAL					
	D	FC	W	L	D	C	FC	W	L	D	C	FC	W	L
MXTG2-STRA300WL2 3000K 12° Spot	6'	554	1.3	1.4	6'	4	324	1.98	1.49	3'	4	520	1.15	2.42
	8'	312	1.8	1.8	8'	5	194	2.58	2.1	4'	6	324	1.49	2.96
	10'	199	2.2	2.3	10'	6	122	3.13	2.67	5'	7	211	1.89	3.48
	12'	138	2.7	2.7	12'	7	83.7	3.82	3.19	6'	9	144	2.55	4.24
MXTG2-STRA300WL2 3000K 24° Narrow Flood	6'	247	2.4	2.2	6'	4	144	3.2	2.64	3'	4	277	1.78	3.22
	8'	139	3.2	3	8'	5	83	4.19	3.35	4'	5	154	2.5	4.28
	10'	88.9	4	3.7	10'	6	53.5	5.22	4.16	5'	7	97.4	3.15	5.36
	12'	61.7	4.8	4.4	12'	6	37.3	6.24	5.03	6'	8	69.1	3.65	6.31
MXTG2-STRA300WL2 3000K 36° Flood	6'	101	3.9	3.5	6'	3	64.5	4.6	3.63	3'	3	122	2.76	4
	8'	56.7	5.2	4.7	8'	4	36.3	6.16	5.01	4'	5	69.2	3.46	5.34
	10'	36.3	6.5	5.8	10'	5	23.2	7.67	6.27	5'	6	45.6	4.33	6.47
	12'	25.2	7.8	7	12'	6	16.1	9.21	7.48	6'	7	32	5.13	7.64
MXTG2-STRA300WL2 3000K 50° Wide Flood	6'	38.4	6.2	5.8	6'	2	28.7	5.76	5.32	3'	3	55.6	3.46	4.18
	8'	21.6	8.2	7.8	8'	3	16	7.76	7.19	4'	4	31.3	4.7	5.5
	10'	13.8	10.3	9.7	10'	3	10.3	9.68	8.97	5'	5	20	5.84	6.89
	12'	9.6	12.4	11.7	12'	4	7.2	11.51	10.67	6'	6	13.9	6.99	8.2

JOB NAME		CATALOG NUMBER	
NOTES		TYPE	

MXTG2-STRA300WL3

Report #: ILL-02222016-01 (12)
 ILL-02222016-02 (24)
 ILL-02222016-03 (36)
 ILL-02222016-04 (50)

MXTG2-STRA300

Ceiling Thickness Multipliers:
 5/8" Thickness (x 1.00)
 1" Thickness (x 0.86)
 2" Thickness (x 0.72)

MXTG2-STRR300

Ceiling Thickness Multipliers:
 5/8" Thickness (x 0.91)
 1" Thickness (x 0.73)
 2" Thickness (x 0.55)

CCT MULTIPLIERS:

	82 CRI	92 CRI
2700K	(x 0.93)	(x 0.76)
3000K	(x 1.00)	(x 0.87)
3500K	(x 1.00)	(x 0.87)
4100K	(x 1.00)	(x 0.87)

EMERGENCY MULTIPLIER:

7W Emergency (x 0.35)
 12W Emergency (x 0.59)

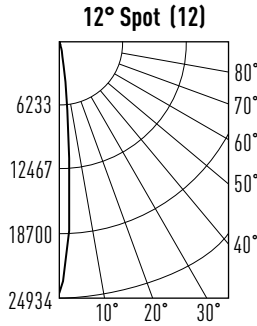

Watts: 26
 Lumens: 1714
 LPW: 66
 CCT: 3000K

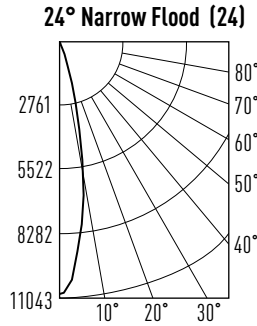

Watts: 26
 Lumens: 1805
 LPW: 69
 CCT: 3000K

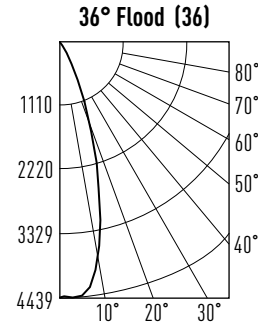

Watts: 26
 Lumens: 1702
 LPW: 65
 CCT: 3000K

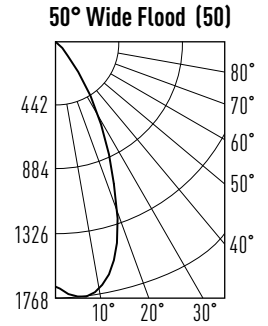

Watts: 26
 Lumens: 1452
 LPW: 56
 CCT: 3000K

Candelas at Nadir

Degree	Candela
0°	24316
5°	9413
15°	856
25°	214
35°	72
45°	10

Candelas at Nadir

Degree	Candela
0°	10838
5°	9042
15°	2703
25°	330
35°	42
45°	5

Candelas at Nadir

Degree	Candela
0°	4425
5°	4411
15°	2626
25°	793
35°	160
45°	15a

Candelas at Nadir

Degree	Candela
0°	1687
5°	1763
15°	1558
25°	890
35°	361
45°	96

APPLICATION DATA:

W and **L** are the outer points where the candle power drops to 50% of maximum. **FC** are the initial foot candles at the center of the beam.

- W** Beam width
- L** Beam length
- C** Distance to center of beam
- D** Distance
- FC** Footcandles

Illuminated width & length are based upon point at which illuminance falls to 50% of center illuminance. Recommended spacing is based upon uniform illuminance aiming angle is the angle between the lamp axis and the perpendicular to the illuminated plane.

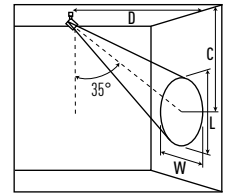
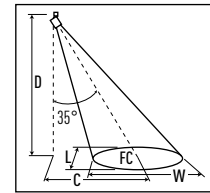
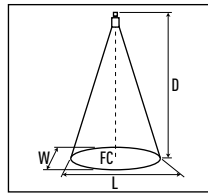

	0° HORIZONTAL				35° HORIZONTAL				35° VERTICAL					
	D	FC	W	L	D	C	FC	W	L	D	C	FC	W	L
MXTG2-STRA300WL3 3000K 12° Spot	6'	675	1.3	1.4	6'	4	396	1.98	1.49	3'	4	635	1.15	2.42
	8'	380	1.8	1.8	8'	5	236	2.58	2.1	4'	6	396	1.49	2.96
	10'	243	2.2	2.3	10'	6	149	3.13	2.67	5'	7	258	1.89	3.48
	12'	169	2.7	2.7	12'	7	102	3.82	3.19	6'	9	176	2.55	4.24
MXTG2-STRA300WL3 3000K 24° Narrow Flood	6'	301	2.4	2.2	6'	4	176	3.2	2.64	3'	4	337	1.78	3.22
	8'	169	3.2	3	8'	5	101	4.19	3.35	4'	5	188	2.5	4.28
	10'	108	4	3.7	10'	6	65.2	5.22	4.16	5'	7	119	3.15	5.36
	12'	75.3	4.8	4.4	12'	6	45.4	6.24	5.03	6'	8	84.3	3.65	6.31
MXTG2-STRA300WL3 3000K 36° Flood	6'	123	3.9	3.5	6'	3	78.7	4.6	3.63	3'	3	142	2.76	4
	8'	69.1	5.2	4.7	8'	4	44.3	6.16	5.01	4'	5	84.4	3.46	5.34
	10'	44.3	6.5	5.8	10'	5	28.3	7.67	6.27	5'	6	55.6	4.33	6.47
	12'	30.7	7.8	7	12'	6	19.7	9.21	7.48	6'	7	39	5.13	7.64
MXTG2-STRA300WL3 3000K 50° Wide Flood	6'	46.9	6.2	5.8	6'	2	35.1	5.76	5.32	3'	3	67.8	3.46	4.18
	8'	26.4	8.2	7.8	8'	3	19.5	7.76	7.19	4'	4	38.2	4.7	5.5
	10'	16.9	10.3	9.7	10'	3	12.5	9.68	8.97	5'	5	24.4	5.84	6.89
	12'	11.7	12.4	11.7	12'	4	8.8	11.51	10.67	6'	6	17	6.99	8.2