

# MXG2ASTR

## 3.5" MX G2 LED Square Pinhole Wood Ceiling

JOB NAME		CATALOG NUMBER	
NOTES		TYPE	

### ELECTRICAL DATA

LED LIGHT ENGINE	System Wattage *	CCT / CRI	Delivered Lumens **	Lumens Per Watt
L0	10W	3000K / 82 CRI	700lm	70
L1	16W	3000K / 82 CRI	1000lm	63
L2	20W	3000K / 82 CRI	1150lm	58
L3	26W	3000K / 82 CRI	1600lm	62

\*System Wattage include driver and LED Module consumption. \*\*Delivered lumens will vary depending on trim, CCT, CRI, optic and ceiling thickness

### FEATURES

- Multiple architectural trim options
- High center beam spot up to 21,700 CBCP
- Dedicated 9° with field changeable 12°, 24°, 36° & 50° optics

### LED LIGHT ENGINE

- 92 CRI & 82 CRI in 2700K, 3000K, 3500K or 4100K with 2SDCM binning
- >50,000 hours L70 (rated life at 70% output)

### ELECTRICAL SYSTEM

- (Non-IC) Dedicated voltage options of 120V or 277V. Must be specified in catalog code.
- (-IC) Universal 120V/277V input
- This product complies with IEEE C62.41 for surge endurance up to 2.5KV. Additional surge protection recommended. Damage from power surge is not covered by warranty.

### DIMMING

- 0-10V Dimming 1%
- Forward/reverse dimming 1% (120V only)
- EldoLED 0-10V 0.1% or 1%
- Lutron® LDE1 Hi-Lume 1% EcoSystem LED driver with Soft-on, Fade-to-Black dimming technology
- DMX512 RDM 0.1%

### HOUSING

- Heavy duty black powder coated 18 gauge steel frame
- Standard housing accommodates 5/8" ceiling thickness
- Extended collar options available for ceilings up to 1" or 2" thick, must specify either EC1 or EC2

### TRIM SPECIFICATION

Aiming with locking 35° vertical and 360° horizontal adjustment with 1/2" regress. See fixture aiming chart on page 2. High quality trims are die-cast using A380 aluminum and finished with durable powder coat available in multiple finishes, black interior standard.

### INSTALLATION

Housing types include IC Air-Tight or Non-IC Rated (must specify). Non-IC rated housings must be kept at a minimum of 3" away from insulation. Butterfly brackets are compatible with C-channel, adjustable bar hangers (14"-25") and EMT. C-channel is recommended for T-bar ceilings. Bar hangers must be ordered separately. Max. ambient temperature: 95°F (35°C).

### EMERGENCY BACKUP

Remote test switch included. External battery operates LED load at a minimum of 400 to 650 lumens for 90 minutes, depending on backup wattage selected. See trim multipliers for detailed performance. Servicing requires above ceiling access.

### ACCESSORIES

Luminaire will accommodate (2) accessories, accessory holder required, see page 2.

### LISTING / WARRANTY

- 5-Year Intense LED Limited Warranty
- ETL listed to US and Canadian standards for damp locations
- (-IC Only) Air-Tight Certified ASTM E283
- (-IC Only) ETL listed for direct contact w/insulation
- ENERGY STAR® Qualified<sup>1</sup>
- Can be used to comply with 2016 Title 24, Part 6, JA8 high efficacy LED light source requirements<sup>2</sup>

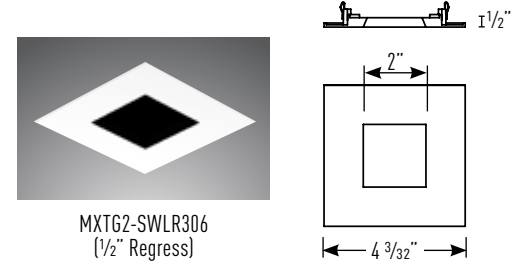

MXTG2-SWLR306  
(1/2" Regress)

Recommended 4 1/8" precision routing fitment of wood trim; using a hole saw may result in improper fitment, uneven gaps and/or light leak

Housing dimensions are on Page 2

### Available Trim Finishes



### Housing Part Number (Example: MXG2ASTR-ICL1)

Housing	Installation Type	Ceiling Thickness	Wattage	Dimming	Voltage	Options
MXG2ASTR	-NC (Non-IC)	blank (5/8")	L0 (10 Watts)	blank (Non-Dimming)	blank (Non-IC: 120V -IC: 120V/277V)	1100 (C-Channel Bar Hangers)
		EC1 (1")	L1 (16 Watts)	DELV <sup>6</sup> (Phase Dimming)		1200 (Flat Bar Hangers)
	-IC (Air-Tight IC)	EC2 (2")	L2 (20 Watts)	D101 (0-10V Dimming 1%)	27 (277V Non-IC Only, for -IC housing options use blank)	1400 (Wood Joist Bar Hangers)
			L3 <sup>3</sup> (26 Watts)	ED10V1 <sup>5</sup> (eldoLED 0-10V 1%) ED10V01 <sup>5</sup> (eldoLED 0-10V 0.1%) LUT <sup>6</sup> (Lutron® LDE1 EcoSystem 1%) DMXR <sup>7</sup> (DMX512 RDM 0.1%)		-EM7 <sup>8</sup> (7W Emergency Backup <a href="#">IOTA Part #ILB-CP07-A</a> ) -EM12 <sup>9,9</sup> (12W Emergency Backup <a href="#">IOTA Part #ILB-CP12-A</a> )

### Trim Part Number (Example: MXTG2-SWLR306WL13024)

Trim	Finish	Wattage	CCT / CRI	Optic
MXTG2-SWLR306 (1/2" Regress)	W (White)	L0 (10 Watts)	27 (2700K / 82 CRI)	09 <sup>10</sup> (9° Narrow Spot)
	B (Black)	L1 (16 Watts)	279 (2700K / 92 CRI)	12 (12° Spot)
	SN (Satin Nickel)	L2 (20 Watts)	30 (3000K / 82 CRI)	24 (24° Narrow Flood)
	AB (Antique Bronze)	L3 <sup>3</sup> (26 Watts)	309 (3000K / 92 CRI)	36 (36° Flood)
			35 (3500K / 82 CRI)	50 (50° Wide Flood)
			359 (3500K / 92 CRI)	
			41 (4100K / 82 CRI)	
			419 (4100K / 92 CRI)	

### Notes:

- ENERGY STAR® Qualified (White reflectors only). Excludes: L2, L3, 92 CRI & 9° options
- L0 only; Excludes: 82 CRI & 9° options
- L3 available with Non-IC housings only
- Available in 120V only
- Not Available in L3
- Not Available in L2 & L3
- DMX512 RDM not available in L0 & L1
- Access above ceiling required
- Not available in L0
- 9° NS available in 279 with L0 or L1 Only

# MXG2ASTR

3.5" MX G2 LED Square Pinhole Wood Ceiling

JOB NAME		CATALOG NUMBER	
NOTES		TYPE	

## NON-IC & AIR TIGHT IC DIMENSIONS

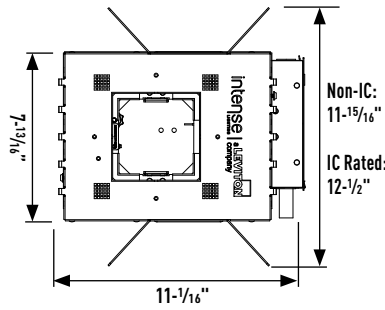
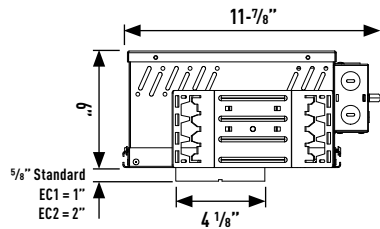

Ceiling Cut Out: 4 1/8"

## Plaster Frame Accommodation

Collar Type	Standard	EC1	EC2
Max Ceiling Thickness	Up-to 5/8"	Up-to 1"	Up-to 2"

## Fixture Aiming - Horizontal Adjustment

1/2" Regress Trims	Full 360°	Full 360°	Full 360°
--------------------	-----------	-----------	-----------

## ACCESSORIES

Luminaire will accommodate (2) accessories, accessory holder required.

## INSTALLATION

1. Rotate release cap by turning counter clockwise.
2. Install accessories into accessory holder and replace accessory holder's retaining clip.
3. Place accessory holder and accessory flush against optic and replace release cap.

### Accessories

<b>LH47</b>	(Accessory Holder, Black)
<b>LH47W</b>	(Accessory Holder, White)
<b>PFLMB-47</b>	(Hex Louver, Black)
<b>PFL1-47</b>	(Prismatic Spread Lens)
<b>PFL2-47</b>	(Linear Spread Lens)
<b>PFL4-47</b>	(Soft Focus Lens)

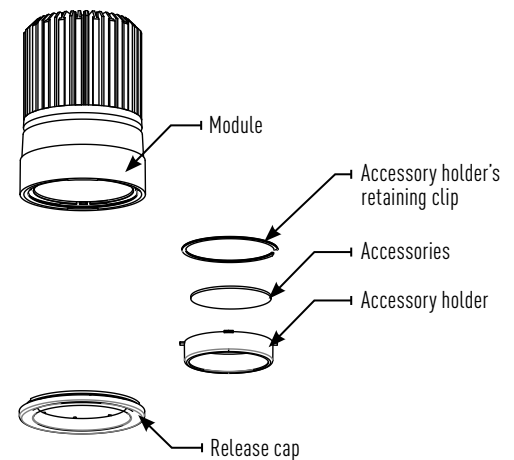

## OPTICS REPLACEMENT

1. Rotate release cap by turning counter clockwise.
2. Install accessories into accessory holder and replace accessory holder's retaining clip.
3. Place accessory holder and accessory flush against optic and replace release cap.

### Optics

<b>IP-OP4712</b>	(12° Spot)
<b>IP-OP4724</b>	(24° Narrow Flood)
<b>IP-OP4736</b>	(36° Flood)
<b>IP-OP4750</b>	(50° Wide Flood)

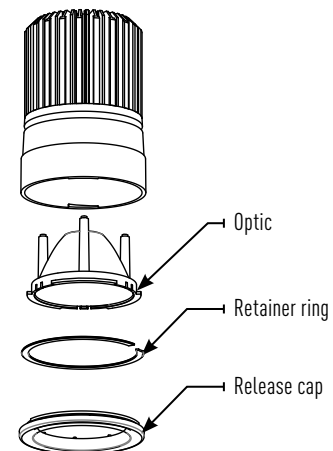

JOB NAME		CATALOG NUMBER	
NOTES		TYPE	

## MXTG2-STRA306WLO

Report #:  
 ILL-02122016-11.3 (12)  
 ILL-02122016-10.3 (24)  
 ILL-02162016-02.3 (36)  
 ILL-02122016-06.3 (50)

**MXTG2-SWLR306**  
 Ceiling Thickness Multipliers:  
 5/8" Thickness (x 0.98)  
 1" Thickness (x 0.87)  
 2" Thickness (x 0.59)

### CCT MULTIPLIERS:

	<b>82 CRI</b>	<b>92 CRI</b>
2700K	(x 0.93)	(x 0.76)
3000K	(x 1.00)	(x 0.87)
3500K	(x 1.00)	(x 0.87)
4100K	(x 1.00)	(x 0.87)

### EMERGENCY MULTIPLIER:

7W Emergency (x 0.70)

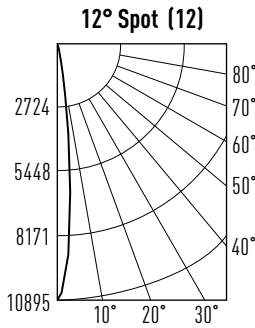

Watts: 10  
 Lumens: 582  
 LPW: 58  
 CCT: 3000K

### Candelas at Nadir

Degree	Candela
0°	10895
5°	6333
15°	468
25°	43
35°	9
45°	2

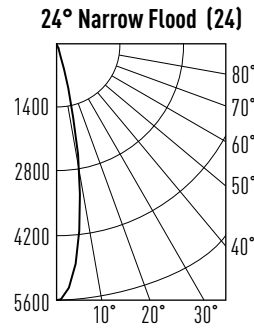

Watts: 10  
 Lumens: 715  
 LPW: 72  
 CCT: 3000K

### Candelas at Nadir

Degree	Candela
0°	5600
5°	4829
15°	1002
25°	48
35°	4
45°	1

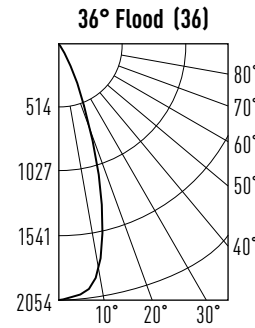

Watts: 10  
 Lumens: 689  
 LPW: 69  
 CCT: 3000K

### Candelas at Nadir

Degree	Candela
0°	2054
5°	2020
15°	1333
25°	380
35°	55
45°	1

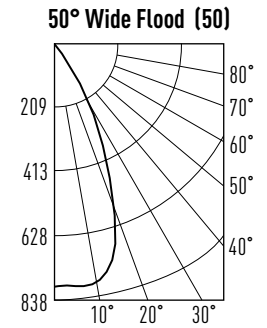

Watts: 10  
 Lumens: 577  
 LPW: 58  
 CCT: 3000K

### Candelas at Nadir

Degree	Candela
0°	785
5°	785
15°	724
25°	383
35°	102
45°	4

### APPLICATION DATA:

**W** and **L** are the outer points where the candle power drops to 50% of maximum. **FC** are the initial footcandles at the center of the beam.

- W** Beam width
- L** Beam length
- C** Distance to center of beam
- D** Distance
- FC** Footcandles

Illuminated width & length are based upon point at which illuminance falls to 50% of center illuminance. Recommended spacing is based upon uniform illuminance aiming angle is the angle between the lamp axis and the perpendicular to the illuminated plane.

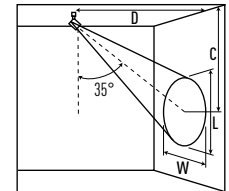
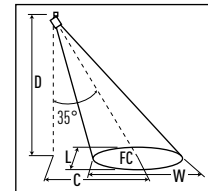
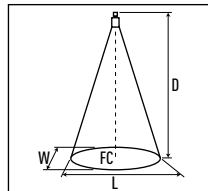

	0° HORIZONTAL				35° HORIZONTAL				35° VERTICAL					
	D	FC	W	L	D	C	FC	W	L	D	C	FC	W	L
<b>MXTG2-STRA306WLO</b> 3000K 12° Spot	6'	303	1.4	1.1	6'	4	172	1.93	1.28	3'	4	316	1.06	2.13
	8'	170	1.8	1.4	8'	5	97.1	1.59	2.61	4'	6	172	1.28	2.94
	10'	109	2.3	1.8	10'	7	59.9	3.37	2.19	5'	7	118	1.48	3.42
	12'	75.7	2.8	2.1	12'	8	43	3.87	2.62	6'	8	79.1	1.84	4.19
<b>MXTG2-STRA306WLO</b> 3000K 24° Narrow Flood	6'	156	2.2	1.9	6'	4	87.9	3.07	2.34	3'	4	175	1.49	2.95
	8'	87.5	2.9	2.6	8'	5	50.1	4.01	2.99	4'	5	98.4	2.08	3.88
	10'	56	3.7	3.2	10'	6	31.6	5.04	3.76	5'	7	61.5	2.76	4.9
	12'	38.9	4.4	3.9	12'	8	22	6.05	4.57	6'	8	43.8	3.17	5.73
<b>MXTG2-STRA306WLO</b> 3000K 36° Flood	6'	57.1	3.9	3.2	6'	3	38	4.44	3.13	3'	3	71.7	2.33	4
	8'	32.1	5.2	4.2	8'	4	21.4	5.89	4.27	4'	4	40.4	3.04	5.44
	10'	20.5	6.5	5.3	10'	5	13.7	7.38	5.35	5'	5	25.8	3.77	6.77
	12'	14.3	7.8	6.3	12'	6	9.5	8.81	6.45	6'	7	17.9	4.57	8.09
<b>MXTG2-STRA306WLO</b> 3000K 50° Wide Flood	6'	21.8	5.6	5.1	6'	2	18.7	4.6	4.89	3'	3	30.7	3.6	4.69
	8'	12.3	7.4	6.9	8'	3	10.5	6.13	6.49	4'	4	17.3	4.88	6.2
	10'	7.9	9.3	8.6	10'	4	6.6	7.76	8.11	5'	5	11	6.16	7.74
	12'	5.5	11.2	10.3	12'	4	4.7	9.27	9.67	6'	6	7.7	7.35	9.32

JOB NAME		CATALOG NUMBER	
NOTES		TYPE	

## MXTG2-STRA306WL1

Report #: ILL-02122016-11.2 (12)  
 ILL-02122016-10.2 (24)  
 ILL-02162016-02.2 (36)  
 ILL-02122016-06.2 (50)

**MXTG2-SWLR306**  
 Ceiling Thickness Multipliers:  
 5/8" Thickness (x 0.98)  
 1" Thickness (x 0.87)  
 2" Thickness (x 0.59)

### CCT MULTIPLIERS:

	<b>82 CRI</b>	<b>92 CRI</b>
2700K	(x 0.93)	(x 0.76)
3000K	(x 1.00)	(x 0.87)
3500K	(x 1.00)	(x 0.87)
4100K	(x 1.00)	(x 0.87)

### EMERGENCY MULTIPLIER:

7W Emergency	(x 0.50)
12W Emergency	(x 0.85)

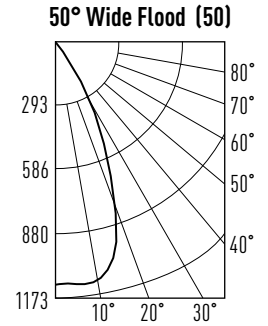
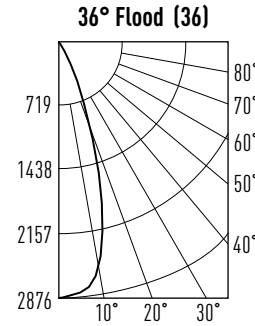
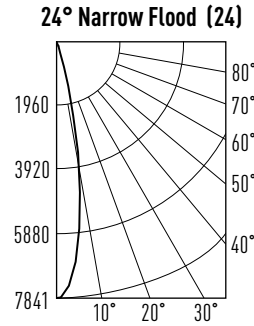
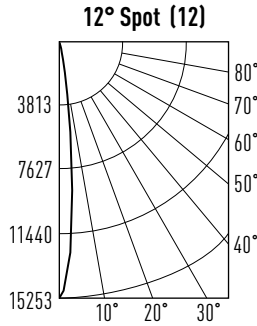

Watts: 15.4  
 Lumens: 814  
 LPW: 53  
 CCT: 3000K

Watts: 15.4  
 Lumens: 1001  
 LPW: 65  
 CCT: 3000K

Watts: 15.4  
 Lumens: 964  
 LPW: 63  
 CCT: 3000K

Watts: 15.4  
 Lumens: 808  
 LPW: 52  
 CCT: 3000K

### Candelas at Nadir

Degree	Candela
0°	15253
5°	8866
15°	655
25°	60
35°	13
45°	2

### Candelas at Nadir

Degree	Candela
0°	7841
5°	6760
15°	1402
25°	67
35°	6
45°	1

### Candelas at Nadir

Degree	Candela
0°	2876
5°	2828
15°	1867
25°	532
35°	77
45°	1

### Candelas at Nadir

Degree	Candela
0°	1099
5°	1099
15°	1013
25°	536
35°	143
45°	5

### APPLICATION DATA:

**W** and **L** are the outer points where the candle power drops to 50% of maximum. **FC** are the initial foot candles at the center of the beam.

- W** Beam width
- L** Beam length
- C** Distance to center of beam
- D** Distance
- FC** Footcandles

Illuminated width & length are based upon point at which illuminance falls to 50% of center illuminance. Recommended spacing is based upon uniform illuminance aiming angle is the angle between the lamp axis and the perpendicular to the illuminated plane.

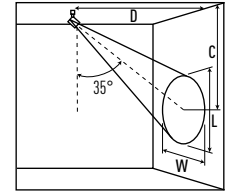
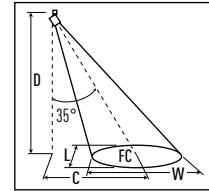
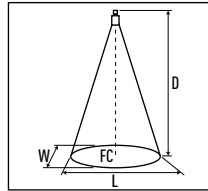

	0° HORIZONTAL				35° HORIZONTAL				35° VERTICAL					
	D	FC	W	L	D	C	FC	W	L	D	C	FC	W	L
<b>MXTG2-STRA306WL1</b> 3000K 12° Spot	6'	424	1.4	1.1	6'	4	241	1.93	1.28	3'	4	443	1.06	2.13
	8'	238	1.8	1.4	8'	5	136	1.59	2.61	4'	6	241	1.28	2.94
	10'	153	2.3	1.8	10'	7	83.9	3.37	2.19	5'	7	165	1.48	3.42
	12'	106	2.8	2.1	12'	8	60.2	3.87	2.62	6'	8	111	1.84	4.19
<b>MXTG2-STRA306WL1</b> 3000K 24° Narrow Flood	6'	218	2.2	1.9	6'	4	123	3.07	2.34	3'	4	246	1.49	2.95
	8'	123	2.9	2.6	8'	5	70.2	4.01	2.99	4'	5	138	2.08	3.88
	10'	78.4	3.7	3.2	10'	6	44.2	5.04	3.76	5'	7	86.1	2.76	4.9
	12'	54.4	4.4	3.9	12'	8	30.8	6.05	4.57	6'	8	61.4	3.17	5.73
<b>MXTG2-STRA306WL1</b> 3000K 36° Flood	6'	79.9	3.9	3.2	6'	3	53.1	4.44	3.13	3'	3	100	2.33	4
	8'	44.9	5.2	4.2	8'	4	29.9	5.89	4.27	4'	4	56.5	3.04	5.44
	10'	28.8	6.5	5.3	10'	5	19.1	7.38	5.35	5'	5	36.2	3.77	6.77
	12'	20	7.8	6.3	12'	6	13.3	8.81	6.45	6'	7	25.1	4.57	8.09
<b>MXTG2-STRA306WL1</b> 3000K 50° Wide Flood	6'	30.5	5.6	5.1	6'	2	26.2	4.6	4.89	3'	3	42.9	3.6	4.69
	8'	17.2	7.4	6.9	8'	3	14.7	6.13	6.49	4'	4	24.2	4.88	6.2
	10'	11	9.3	8.6	10'	4	9.3	7.76	8.11	5'	5	15.5	6.16	7.74
	12'	7.6	11.2	10.3	12'	4	6.5	9.27	9.67	6'	6	10.7	7.35	9.32

JOB NAME		CATALOG NUMBER	
NOTES		TYPE	

## MXTG2-STRA306WL2

Report #: ILL-02122016-11.1 (12)  
 ILL-02122016-10.1 (24)  
 ILL-02162016-02.1 (36)  
 ILL-02122016-06.1 (50)

**MXTG2-SWLR306**  
 Ceiling Thickness Multipliers:  
 5/8" Thickness (x 0.98)  
 1" Thickness (x 0.87)  
 2" Thickness (x 0.59)

### CCT MULTIPLIERS:

	<b>82 CRI</b>	<b>92 CRI</b>
2700K	(x 0.93)	(x 0.76)
3000K	(x 1.00)	(x 0.87)
3500K	(x 1.00)	(x 0.87)
4100K	(x 1.00)	(x 0.87)

### EMERGENCY MULTIPLIER:

7W Emergency	(x 0.40)
12W Emergency	(x 0.68)

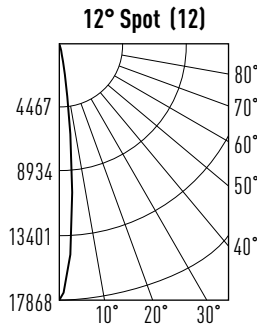

Watts: 20.5  
 Lumens: 954  
 LPW: 47  
 CCT: 3000K

### Candelas at Nadir

Degree	Candela
0°	17868
5°	10385
15°	768
25°	70
35°	15
45°	3

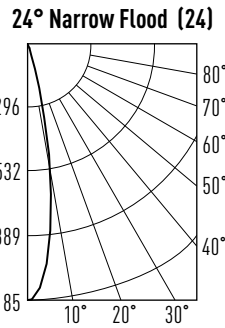

Watts: 20.4  
 Lumens: 1173  
 LPW: 57  
 CCT: 3000K

### Candelas at Nadir

Degree	Candela
0°	9185
5°	7919
15°	1642
25°	79
35°	7
45°	1

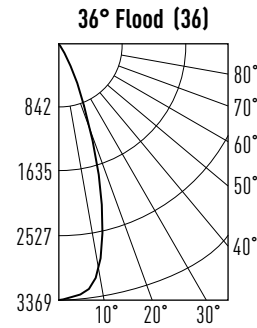

Watts: 20.5  
 Lumens: 1129  
 LPW: 55  
 CCT: 3000K

### Candelas at Nadir

Degree	Candela
0°	3369
5°	3313
15°	2187
25°	623
35°	90
45°	1

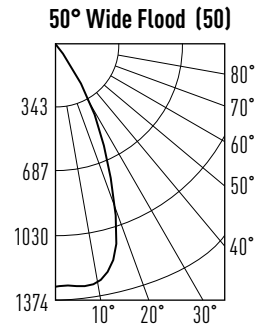

Watts: 20.5  
 Lumens: 946  
 LPW: 46  
 CCT: 3000K

### Candelas at Nadir

Degree	Candela
0°	1287
5°	1287
15°	1187
25°	628
35°	168
45°	6

### APPLICATION DATA:

**W** and **L** are the outer points where the candle power drops to 50% of maximum. **FC** are the initial footcandles at the center of the beam.

- W** Beam width
- L** Beam length
- C** Distance to center of beam
- D** Distance
- FC** Footcandles

Illuminated width & length are based upon point at which illuminance falls to 50% of center illuminance. Recommended spacing is based upon uniform illuminance aiming angle is the angle between the lamp axis and the perpendicular to the illuminated plane.

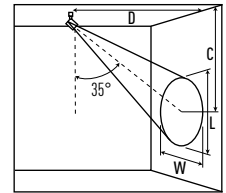
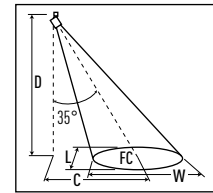
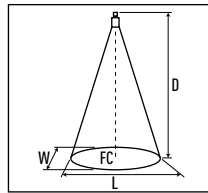

	0° HORIZONTAL				35° HORIZONTAL				35° VERTICAL					
	D	FC	W	L	D	C	FC	W	L	D	C	FC	W	L
<b>MXTG2-STRA306WL2</b> 3000K 12° Spot	6'	496	1.4	1.1	6'	4	282	1.93	1.28	3'	4	519	1.06	2.13
	8'	279	1.8	1.4	8'	5	159	1.59	2.61	4'	6	282	1.28	2.94
	10'	179	2.3	1.8	10'	7	98.2	3.37	2.19	5'	7	193	1.48	3.42
	12'	124	2.8	2.1	12'	8	70.5	3.87	2.62	6'	8	130	1.84	4.19
<b>MXTG2-STRA306WL2</b> 3000K 24° Narrow Flood	6'	255	2.2	1.9	6'	4	144	3.07	2.34	3'	4	288	1.49	2.95
	8'	144	2.9	2.6	8'	5	82.2	4.01	2.99	4'	5	162	2.08	3.88
	10'	91.8	3.7	3.2	10'	6	51.8	5.04	3.76	5'	7	101	2.76	4.9
	12'	63.8	4.4	3.9	12'	8	36	6.05	4.57	6'	8	71.9	3.17	5.73
<b>MXTG2-STRA306WL2</b> 3000K 36° Flood	6'	93.6	3.9	3.2	6'	3	62.3	4.44	3.13	3'	3	118	2.33	4
	8'	52.6	5.2	4.2	8'	4	35	5.89	4.27	4'	4	66.2	3.04	5.44
	10'	33.7	6.5	5.3	10'	5	22.4	7.38	5.35	5'	5	42.4	3.77	6.77
	12'	23.4	7.8	6.3	12'	6	15.6	8.81	6.45	6'	7	29.4	4.57	8.09
<b>MXTG2-STRA306WL2</b> 3000K 50° Wide Flood	6'	35.8	5.6	5.1	6'	2	30.6	4.6	4.89	3'	3	50.3	3.6	4.69
	8'	20.1	7.4	6.9	8'	3	17.2	6.13	6.49	4'	4	28.3	4.88	6.2
	10'	12.9	9.3	8.6	10'	4	10.9	7.76	8.11	5'	5	18.1	6.16	7.74
	12'	8.9	11.2	10.3	12'	4	7.7	9.27	9.67	6'	6	12.6	7.35	9.32

JOB NAME		CATALOG NUMBER	
NOTES		TYPE	

## MXTG2-STRA306WL3

Report #: ILL-02122016-11 (12)  
 ILL-02122016-10 (24)  
 ILL-02162016-02 (36)  
 ILL-02122016-06 (50)

**MXTG2-SWLR306**  
 Ceiling Thickness Multipliers:  
 5/8" Thickness (x 0.98)  
 1" Thickness (x 0.87)  
 2" Thickness (x 0.59)

### CCT MULTIPLIERS:

	<b>82 CRI</b>	<b>92 CRI</b>
2700K	(x 0.93)	(x 0.76)
3000K	(x 1.00)	(x 0.87)
3500K	(x 1.00)	(x 0.87)
4100K	(x 1.00)	(x 0.87)

### EMERGENCY MULTIPLIER:

7W Emergency (x 0.35)  
 12W Emergency (x 0.59)

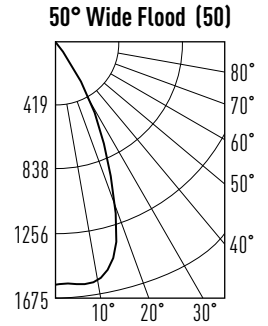
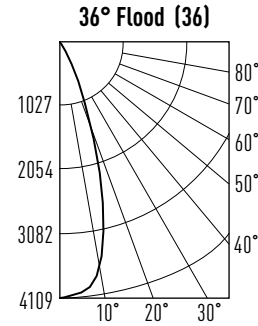
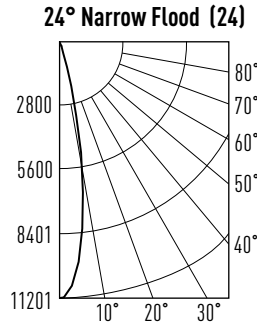
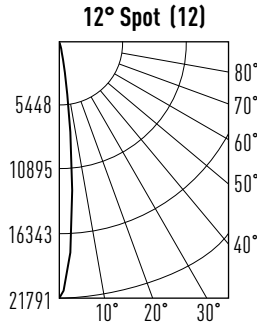

Watts: 25.7  
 Lumens: 1295  
 LPW: 50  
 CCT: 3000K

Watts: 25.7  
 Lumens: 1481  
 LPW: 58  
 CCT: 3000K

Watts: 26  
 Lumens: 1377  
 LPW: 53  
 CCT: 3000K

Watts: 26.1  
 Lumens: 1154  
 LPW: 44  
 CCT: 3000K

### Candelas at Nadir

Degree	Candela
0°	21791
5°	12665
15°	936
25°	86
35°	19
45°	3

### Candelas at Nadir

Degree	Candela
0°	11201
5°	9657
15°	2003
25°	96
35°	9
45°	1

### Candelas at Nadir

Degree	Candela
0°	4109
5°	4040
15°	2667
25°	760
35°	109
45°	2

### Candelas at Nadir

Degree	Candela
0°	1570
5°	1570
15°	1447
25°	765
35°	205
45°	7

### APPLICATION DATA:

**W** and **L** are the outer points where the candle power drops to 50% of maximum. **FC** are the initial footcandles at the center of the beam.

- W** Beam width
- L** Beam length
- C** Distance to center of beam
- D** Distance
- FC** Footcandles

Illuminated width & length are based upon point at which illuminance falls to 50% of center illuminance. Recommended spacing is based upon uniform illuminance aiming angle is the angle between the lamp axis and the perpendicular to the illuminated plane.

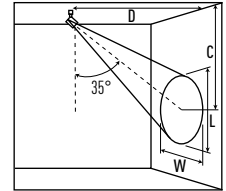
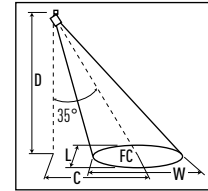
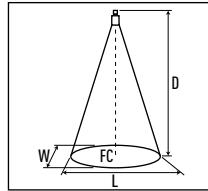

	0° HORIZONTAL				35° HORIZONTAL				35° VERTICAL					
	D	FC	W	L	D	C	FC	W	L	D	C	FC	W	L
<b>MXTG2-STRA306WL3</b> 3000K 12° Spot	6'	605	1.4	1.1	6'	4	344	1.93	1.28	3'	4	633	1.06	2.13
	8'	340	1.8	1.4	8'	5	194	1.59	2.61	4'	6	344	1.28	2.94
	10'	218	2.3	1.8	10'	7	120	3.37	2.19	5'	7	236	1.48	3.42
	12'	151	2.8	2.1	12'	8	86	3.87	2.62	6'	8	158	1.84	4.19
<b>MXTG2-STRA306WL3</b> 3000K 24° Narrow Flood	6'	311	2.2	1.9	6'	4	176	3.07	2.34	3'	4	351	1.49	2.95
	8'	175	2.9	2.6	8'	5	100	4.01	2.99	4'	5	197	2.08	3.88
	10'	112	3.7	3.2	10'	6	63.2	5.04	3.76	5'	7	123	2.76	4.9
	12'	77.8	4.4	3.9	12'	8	44	6.05	4.57	6'	8	87.7	3.17	5.73
<b>MXTG2-STRA306WL3</b> 3000K 36° Flood	6'	114	3.9	3.2	6'	3	75.9	4.44	3.13	3'	3	144	2.33	4
	8'	64.2	5.2	4.2	8'	4	42.7	5.89	4.27	4'	4	80.7	3.04	5.44
	10'	41.1	6.5	5.3	10'	5	27.3	7.38	5.35	5'	5	51.7	3.77	6.77
	12'	28.5	7.8	6.3	12'	6	19	8.81	6.45	6'	7	35.9	4.57	8.09
<b>MXTG2-STRA306WL3</b> 3000K 50° Wide Flood	6'	43.6	5.6	5.1	6'	2	37.4	4.6	4.89	3'	3	61.3	3.6	4.69
	8'	24.5	7.4	6.9	8'	3	21	6.13	6.49	4'	4	34.5	4.88	6.2
	10'	15.7	9.3	8.6	10'	4	13.3	7.76	8.11	5'	5	22.1	6.16	7.74
	12'	10.9	11.2	10.3	12'	4	9.3	9.27	9.67	6'	6	15.3	7.35	9.32