

MXG2DRTR

3.5" MX G2 LED Downlight Wood Ceiling

JOB NAME		CATALOG NUMBER	
NOTES		TYPE	

ELECTRICAL DATA

LED LIGHT ENGINE	System Wattage *	CCT / CRI	Delivered Lumens **	Lumens Per Watt
L0	10W	3000K / 82 CRI	950lm	95
L1	16W	3000K / 82 CRI	1300lm	81
L2	20W	3000K / 82 CRI	1550lm	78
L3	26W	3000K / 82 CRI	1850lm	71

*System Wattage include driver and LED Module consumption. **Delivered lumens will vary depending on trim, CCT, CRI, optic and ceiling thickness

FEATURES

- Multiple architectural trim options
- High center beam spot with up to 24,500 CBCP
- Dedicated 9° with field changeable 12°, 24°, 36° & 50° optics

LED LIGHT ENGINE

- 92 CRI & 82 CRI in 2700K, 3000K, 3500K or 4100K with 2SDCM binning
- >50,000 hours L70 (rated life at 70% output)

ELECTRICAL SYSTEM

- (Non-IC) Dedicated voltage options of 120V or 277V. Must be specified in catalog code.
- (-IC/-CP) Universal 120V/277V input
- This product complies with IEEE C62.41 for surge endurance up to 2.5KV. Additional surge protection recommended. Damage from power surge is not covered by warranty.

DIMMING

- 0-10V Dimming 1%
- Forward/reverse dimming 1% (120V only)
- EldoLED 0-10V 0.1% or 1%
- Lutron® LDE1 Hi-Lume 1% EcoSystem LED driver with Soft-on, Fade-to-Black dimming technology
- DMX512 RDM 0.1%

HOUSING

Heavy duty black powder coated 18 gauge steel frame. Standard plaster frame accommodates 5/8" ceiling thickness. Extended collar options available for ceilings up to 1" or 2" thick, must specify.

TRIM SPECIFICATION

High quality trims are die-cast using A380 aluminum with durable powder coat available in multiple finishes.

INSTALLATION

Housing types include IC Air-Tight, CCEA (Chicago Plenum), or Non-IC Rated (must specify). Non-IC rated housings must be kept at a minimum of 3" away from insulation. Butterfly brackets are compatible with C-channel, adjustable bar hangers (14"-25") and EMT. C-channel is recommended for T-bar ceilings. Bar hangers must be ordered separately. Max. ambient temperature: 95°F (35°C). For ceiling cut out, use of a holesaw may result in improper fitment, uneven gaps, and/or light leak.

EMERGENCY BACKUP

Remote test switch included. External battery operates LED load at a minimum of 500 to 850 lumens for 90 minutes, depending on backup wattage selected. See trim multipliers for detailed performance. Servicing requires above ceiling access. (EM not available with Chicago Plenum)

ACCESSORIES

Luminaire will accommodate (2) accessories, accessory holder required, see page 2.

LISTING / WARRANTY

- 5-Year Intense LED Limited Warranty
- ETL listed to US and Canadian standards for damp locations
- (-IC/-CP Only) Air-Tight Certified ASTM E283
- (-IC/-CP Only) ETL listed for direct contact w/insulation
- ENERGY STAR® Qualified¹
- Can be used to comply with 2016 Title 24, Part 6, JA8 high efficacy LED light source requirements²

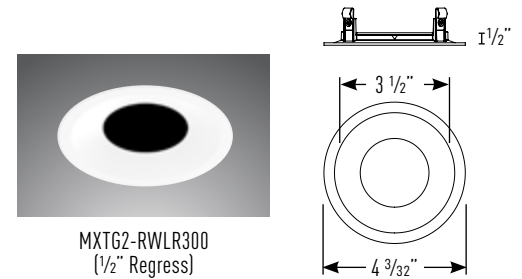

MXTG2-RWLR300
(1/2" Regress)

Recommended 4 1/8" precision routing fitment of wood trim; using a hole saw may result in improper fitment, uneven gaps and/or light leak

Housing dimensions are on Page 2

Available Trim Finishes



Housing Part Number (Example: MXG2DRTR-ICL1)

Housing	Installation Type	Ceiling Thickness	Wattage	Dimming	Voltage	Options
MXG2DRTR	-NC (Non-IC)	blank (5/8")	L0 (10 Watts)	blank (Non-Dimming)	blank (Non-IC: 120V -IC/-CP: 120V/277V)	I100 (C-Channel Bar Hangers)
	-IC (Air-Tight IC)	EC1 ³ (1")	L1 (16 Watts)	DELV ⁵ (Phase Dimming)		I200 (Flat Bar Hangers)
	-CP (Chicago Plenum)	EC2 ³ (2")	L2 (20 Watts)	D101 (0-10V Dimming 1%)	27 (277V Non-IC Only, for -IC/-CP housing options use blank)	I400 (Wood Joist Bar Hangers)
			L3 ⁴ (26 Watts)	ED10V1 ⁶ (eldoLED 0-10V 1%)		-EM7 ⁹ (7W Emergency Backup IOTA Part #ILB-CP07-A)
			ED10V01 ⁶ (eldoLED 0-10V 0.1%)			
			LUT ⁷ (Lutron® LDE1 EcoSystem 1%)			
			DMXR ⁸	DMX512 RDM 0.1%		

Trim Part Number (Example: MXTG2-RWLR300WL13024-SL)

Trim	Finish	Wattage	CCT / CRI	Optic
MXTG2-RWLR300 (1/2" Regress)	W (White)	L0 (10 Watts)	27 (2700K / 82 CRI)	09 ¹¹ (9° Narrow Spot)
		L1 (16 Watts)	279 (2700K / 92 CRI)	12 (12° Spot)
	B (Black)	L2 (20 Watts)	30 (3000K / 82 CRI)	24 (24° Narrow Flood)
		L3 ⁴ (26 Watts)	309 (3000K / 92 CRI)	36 (36° Flood)
	SN (Satin Nickel)		35 (3500K / 82 CRI)	50 (50° Wide Flood)
			359 (3500K / 92 CRI)	
	AB (Antique Bronze)		41 (4100K / 82 CRI)	
			419 (4100K / 92 CRI)	

Notes:

- ENERGY STAR® Qualified (White reflectors only; Excludes: L2, L3, 92 CRI & 9° options)
- Excludes: L2, L3, 82 CRI & 9° options
- EC1/EC2 not available with (-CP) Chicago Plenum
- L3 available with Non-IC housings only
- Available in 120V only
- Not Available in L3
- Not Available in L2 & L3
- DMX512 RDM not available in L0 & L1
- Access above ceiling required & emergency option not available with Chicago plenum
- Not available in L0
- 9° NS available in 279 with L0 or L1 Only

MX WOOD CEILING L/M-1003.23 P-1

INTENSE LIGHTING | 3340 E La Palma Ave, Anaheim, CA 92806 | tel 714 630-9877 | fax 714 630-9883

For Intense Lighting's limited product warranty, go to www.intenselighting.com. For a printed copy of the warranty, you may call 800 961-5321.

© 2023 Intense Lighting, LLC. All rights reserved. Note: This document is subject to change without notice.



MXG2DRTR

3.5" MX G2 LED Downlight Wood Ceiling

JOB NAME		CATALOG NUMBER	
NOTES		TYPE	

NON-IC & AIR TIGHT IC DIMENSIONS

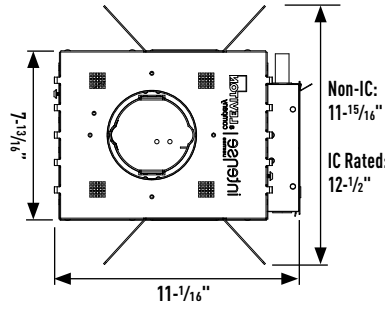
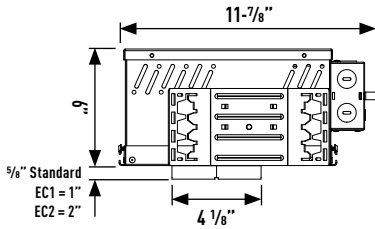

Ceiling Cut Out: 4 1/8"

Plaster Frame Accommodation

Collar Type	Max Ceiling Thickness
Standard	Up-to 5/8"
EC1	Up-to 1"
EC2	Up-to 2"

CCEA CHICAGO PLENUM DIMENSIONS

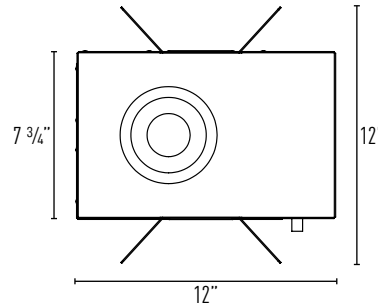
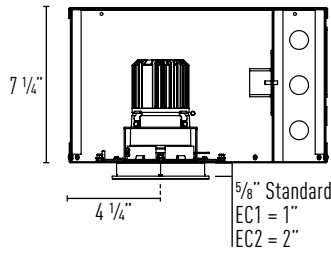

Ceiling Cut Out: 4 1/8"

Plaster Frame Accommodation

Collar Type	Max Ceiling Thickness
Standard	Up-to 5/8"
EC1	Up-to 1"
EC2	Up-to 2"

ACCESSORIES

Luminaire will accommodate (2) accessories, accessory holder required.

INSTALLATION

1. Rotate release cap by turning counter clockwise.
2. Install accessories into accessory holder and replace accessory holder's retaining clip.
3. Place accessory holder and accessory flush against optic and replace release cap.

Accessories

LH47	(Accessory Holder, Black)
LH47W	(Accessory Holder, White)
PFLMB-47	(Hex Louver, Black)
PFL1-47	(Prismatic Spread Lens)
PFL2-47	(Linear Spread Lens)
PFL4-47	(Soft Focus Lens)

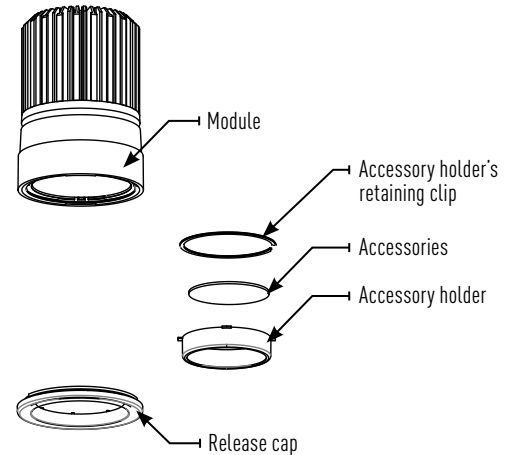

OPTICS REPLACEMENT

1. Rotate release cap by turning counter clockwise.
2. Install accessories into accessory holder and replace accessory holder's retaining clip.
3. Place accessory holder and accessory flush against optic and replace release cap.

Optics

IP-OP4712	(12° Spot)
IP-OP4724	(24° Narrow Flood)
IP-OP4736	(36° Flood)
IP-OP4750	(50° Wide Flood)

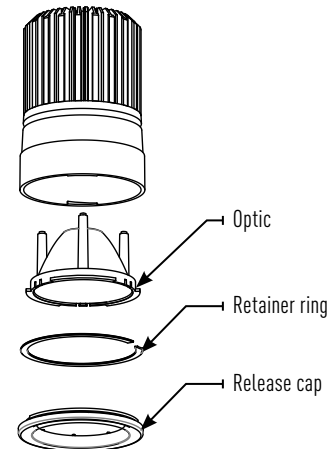

JOB NAME		CATALOG NUMBER	
NOTES		TYPE	

MXTG2-RTRD300WL0

Report #: ILL-01262016-37 (12)
 ILL-01262016-40 (24)
 ILL-01262016-43 (36)
 ILL-01262016-46 (50)

MXTG2-RWLR300

Ceiling Thickness Multipliers:
 5/8" Thickness (x 0.90)
 1" Thickness (x 0.77)
 2" Thickness (x 0.63)

CCT MULTIPLIERS:

	82 CRI	92 CRI
2700K	(x 0.93)	(x 0.76)
3000K	(x 1.00)	(x 0.87)
3500K	(x 1.00)	(x 0.87)
4100K	(x 1.00)	(x 0.87)

EMERGENCY MULTIPLIER:

7W Emergency (x 0.70)

12° Spot (12)

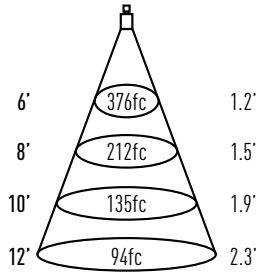

Footcandles at Nadir

Watts: 10
 Lumens: 779
 LPW: 78
 CCT: 3000K

Candelas at Nadir

Degree	CBCP
0°	13539
5°	7504
15°	565
25°	95
35°	34
45°	6

24° Narrow Flood (24)

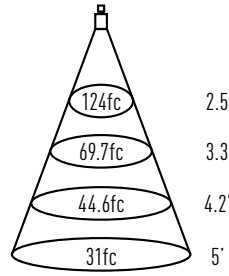

Watts: 10
 Lumens: 863
 LPW: 86
 CCT: 3000K

Candelas at Nadir

Degree	CBCP
0°	4461
5°	3947
15°	1373
25°	226
35°	25
45°	3

36° Flood (36)

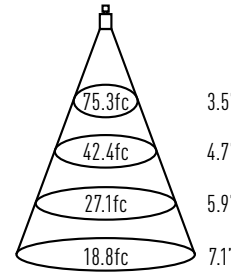

Watts: 10
 Lumens: 955
 LPW: 96
 CCT: 3000K

Candelas at Nadir

Degree	CBCP
0°	2712
5°	2738
15°	1615
25°	448
35°	70
45°	6

50° Wide Flood (50)

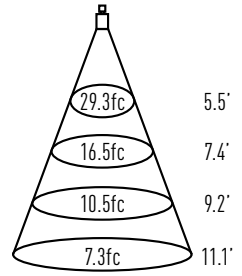

Watts: 10
 Lumens: 837
 LPW: 84
 CCT: 3000K

Candelas at Nadir

Degree	CBCP
0°	1055
5°	1115
15°	991
25°	573
35°	222
45°	56

MXTG2-RTRD300WL1

Report #: ILL-01262016-13 (12)
 ILL-01262016-16 (24)
 ILL-01262016-19 (36)
 ILL-01262016-22 (50)

MXTG2-RWLR300

Ceiling Thickness Multipliers:
 5/8" Thickness (x 0.90)
 1" Thickness (x 0.77)
 2" Thickness (x 0.63)

CCT MULTIPLIERS:

	82 CRI	92 CRI
2700K	(x 0.93)	(x 0.76)
3000K	(x 1.00)	(x 0.87)
3500K	(x 1.00)	(x 0.87)
4100K	(x 1.00)	(x 0.87)

EMERGENCY MULTIPLIER:

7W Emergency (x 0.50)
 12W Emergency (x 0.85)

12° Spot (12)

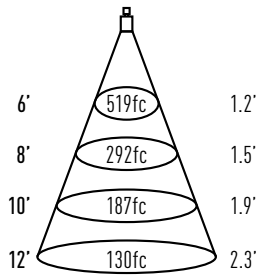

Footcandles at Nadir

Watts: 15.6
 Lumens: 1083
 LPW: 69
 CCT: 3000K

Candelas at Nadir

Degree	CBCP
0°	18687
5°	10403
15°	794
25°	127
35°	48
45°	8

24° Narrow Flood (24)

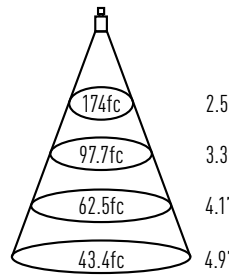

Watts: 15.6
 Lumens: 1199
 LPW: 77
 CCT: 3000K

Candelas at Nadir

Degree	CBCP
0°	6250
5°	5532
15°	1904
25°	317
35°	32
45°	4

36° Flood (36)

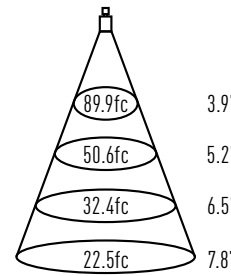

Watts: 15.6
 Lumens: 1327
 LPW: 85
 CCT: 3000K

Candelas at Nadir

Degree	CBCP
0°	3235
5°	3228
15°	2163
25°	707
35°	135
45°	14

50° Wide Flood (50)

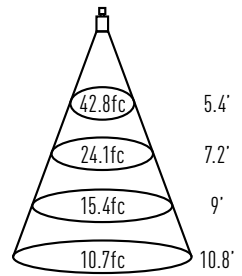

Watts: 15.6
 Lumens: 1172
 LPW: 75
 CCT: 3000K

Candelas at Nadir

Degree	CBCP
0°	1540
5°	1624
15°	1411
25°	789
35°	301
45°	77

JOB NAME		CATALOG NUMBER	
NOTES		TYPE	

MXTG2-RTRD300WL2

Report #: ILL-01262016-25 (12)
 ILL-01262016-28 (24)
 ILL-01262016-31 (36)
 ILL-01262016-34 (50)

MXTG2-RWLR300

Ceiling Thickness Multipliers:
 5/8" Thickness (x 0.90)
 1" Thickness (x 0.77)
 2" Thickness (x 0.63)

CCT MULTIPLIERS:

	82 CRI	92 CRI
2700K	(x 0.93)	(x 0.76)
3000K	(x 1.00)	(x 0.87)
3500K	(x 1.00)	(x 0.87)
4100K	(x 1.00)	(x 0.87)

EMERGENCY MULTIPLIER:

7W Emergency (x 0.40)
 12W Emergency (x 0.68)

12° Spot (12)

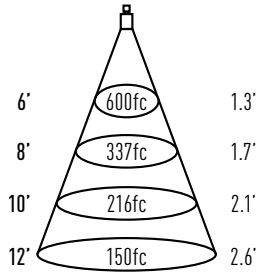

Watts: 20.4
 Lumens: 1354
 LPW: 66
 CCT: 3000K

Candelas at Nadir

Degree	CBCP
0°	21591
5°	13700
15°	796
25°	173
35°	68
45°	11

24° Narrow Flood (24)

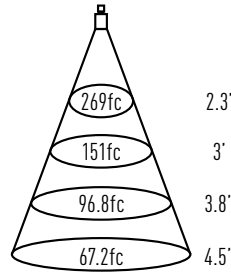

Watts: 20.4
 Lumens: 1533
 LPW: 75
 CCT: 3000K

Candelas at Nadir

Degree	CBCP
0°	9680
5°	8164
15°	2346
25°	275
35°	33
45°	5

36° Flood (36)

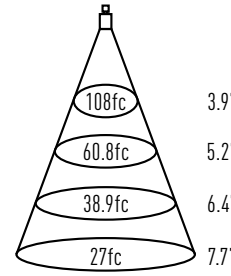

Watts: 20.4
 Lumens: 1558
 LPW: 76
 CCT: 3000K

Candelas at Nadir

Degree	CBCP
0°	3894
5°	3806
15°	2527
25°	828
35°	166
45°	15

50° Wide Flood (50)

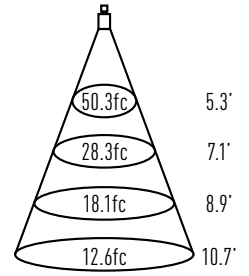

Watts: 20.4
 Lumens: 1353
 LPW: 66
 CCT: 3000K

Candelas at Nadir

Degree	CBCP
0°	1809
5°	1894
15°	1633
25°	908
35°	346
45°	88

MXTG2-RTRD300WL3

Report #: ILL-01262016-10 (12)
 ILL-01262016-07 (24)
 ILL-01262016-01 (36)
 ILL-01262016-04 (50)

MXTG2-RWLR300

Ceiling Thickness Multipliers:
 5/8" Thickness (x 0.90)
 1" Thickness (x 0.77)
 2" Thickness (x 0.63)

CCT MULTIPLIERS:

	82 CRI	92 CRI
2700K	(x 0.93)	(x 0.76)
3000K	(x 1.00)	(x 0.87)
3500K	(x 1.00)	(x 0.87)
4100K	(x 1.00)	(x 0.87)

EMERGENCY MULTIPLIER:

7W Emergency (x 0.35)
 12W Emergency (x 0.59)

12° Spot (12)

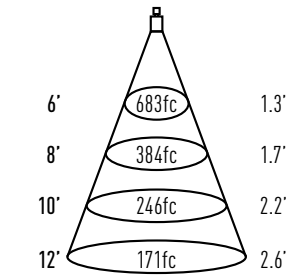

Watts: 26.3
 Lumens: 1571
 LPW: 60
 CCT: 3000K

Candelas at Nadir

Degree	CBCP
0°	24594
5°	15787
15°	896
25°	196
35°	73
45°	13

24° Narrow Flood (24)

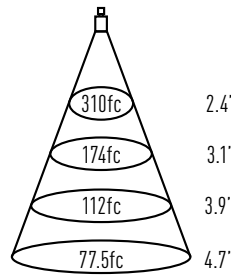

Watts: 26.3
 Lumens: 1876
 LPW: 71
 CCT: 3000K

Candelas at Nadir

Degree	CBCP
0°	11154
5°	9641
15°	2938
25°	345
35°	40
45°	6

36° Flood (36)

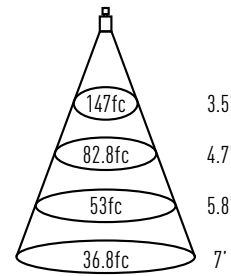

Watts: 26.4
 Lumens: 1809
 LPW: 69
 CCT: 3000K

Candelas at Nadir

Degree	CBCP
0°	5302
5°	5217
15°	3025
25°	821
35°	142
45°	14

50° Wide Flood (50)

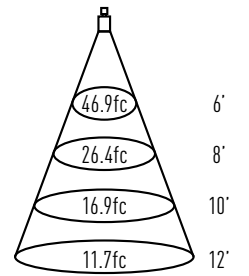

Watts: 26.3
 Lumens: 1457
 LPW: 55
 CCT: 3000K

Candelas at Nadir

Degree	CBCP
0°	1688
5°	1718
15°	1588
25°	999
35°	424
45°	121