

MXG2DRTR

3.5" MX G2 LED Lensed Downlight Wood Ceiling - Wet Location

JOB NAME		CATALOG NUMBER	
NOTES		TYPE	

ELECTRICAL DATA

LED LIGHT ENGINE	System Wattage *	CCT / CRI	Delivered Lumens **	Lumens Per Watt
L0	10W	3000K / 82 CRI	850lm	85
L1	16W	3000K / 82 CRI	1200lm	75
L2	20W	3000K / 82 CRI	1400lm	70
L3	26W	3000K / 82 CRI	1700lm	65

*System Wattage include driver and LED Module consumption. **Delivered lumens will vary depending on trim, CCT, CRI, optic and ceiling thickness

FEATURES

- Multiple architectural trim options
- High center beam spot with up to 22,600 CBCP
- Dedicated 9° with field changeable 12°, 24°, 36° & 50° optics

LED LIGHT ENGINE

- 92 CRI & 82 CRI in 2700K, 3000K, 3500K or 4100K with 2SDCM binning
- >50,000 hours L70 (rated life at 70% output)

ELECTRICAL SYSTEM

- (Non-IC) Dedicated voltage options of 120V or 277V. Must be specified in catalog code.
- (-IC/-CP) Universal 120V/277V input
- This product complies with IEEE C62.41 for surge endurance up to 2.5KV. Additional surge protection recommended. Damage from power surge is not covered by warranty.

DIMMING

- 0-10V Dimming 1%
- Forward/reverse dimming 1% (120V only)
- EldoLED 0-10V 0.1% or 1%
- Lutron® LDE1 Hi-Lume 1% EcoSystem LED driver with Soft-on, Fade-to-Black dimming technology
- DMX512 RDM 0.1%

HOUSING

Heavy duty black powder coated 18 gauge steel frame. Standard plaster frame accommodates 5/8" ceiling thickness. Extended collar options available for ceilings up to 1" or 2" thick, must specify.

TRIM SPECIFICATION

High quality trims are die-cast using A380 aluminum with durable powder coat available in multiple finishes. Trim is available with solite, clear tempered or frosted lens, must specify.

INSTALLATION

Housing types include IC Air-Tight, CCEA (Chicago Plenum), or Non-IC Rated (must specify). Non-IC rated housings must be kept at a minimum of 3" away from insulation. Butterfly brackets are compatible with C-channel, adjustable bar hangers (14"-25") and EMT. C-channel is recommended for T-bar ceilings. Bar hangers must be ordered separately. Max. ambient temperature: 95°F (35°C). For ceiling cut out, use of a holesaw may result in improper fitment, uneven gaps, and/or light leak.

EMERGENCY BACKUP

Remote test switch included. External battery operates LED load at a minimum of 500 to 850 lumens for 90 minutes, depending on backup wattage selected. See trim multipliers for detailed performance. Servicing requires above ceiling access. (EM not available with Chicago Plenum)

LISTING / WARRANTY

- 5-Year Intense LED Limited Warranty
- ETL listed to US and Canadian standards for wet locations
- (-IC/-CP Only) Air-Tight Certified ASTM E283
- (-IC/-CP Only) ETL listed for direct contact w/insulation
- (-CP Only) CCEA Chicago Plenum
- ENERGY STAR® Qualified ¹
- Can be used to comply with 2016 Title 24, Part 6, JA8 high efficacy LED light source requirements ²

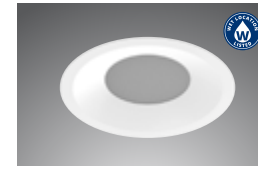

MXTG2-RWLR302
(1/2" Regress with Lens)

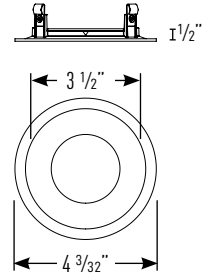

Recommended 4 1/8" precision routing fitment of wood trim; using a hole saw may result in improper fitment, uneven gaps and/or light leak

Housing dimensions are on Page 2

Available Trim Finishes



Housing Part Number (Example: MXG2DRTR-ICL1)

Housing	Installation Type	Ceiling Thickness	Wattage	Dimming	Voltage	Options
MXG2DRTR	-NC (Non-IC)	blank (5/8")	L0 (10 Watts)	blank (Non-Dimming)	blank (Non-IC: 120V	I100 (C-Channel Bar Hangers)
	-IC (Air-Tight IC)	EC1 ³ (1")	L1 (16 Watts)	DELV ⁵ (Phase Dimming)	-IC/-CP: 120V/277V)	I200 (Flat Bar Hangers)
	-CP (Chicago Plenum)	EC2 ³ (2")	L2 (20 Watts)	D101 (0-10V Dimming 1%)	27 (277V Non-IC Only, for -IC/-CP housing options use blank)	I400 (Wood Joist Bar Hangers)
			L3 ⁴ (26 Watts)	ED10V1 ⁶ (eldoLED 0-10V 1%)		EM7⁹ (7W Emergency Backup IOTA Part #ILB-CP07-A)
		ED10V01 ⁶ (eldoLED 0-10V 0.1%)		EM12^{9,10} (12W Emergency Backup IOTA Part #ILB-CP12-A)		
		LUT ⁷ (Lutron® LDE1 EcoSystem 1%)	DMXR ⁸ (DMX512 RDM 0.1%)			

Trim Part Number (Example: MXTG2-RWLR302WL13024-SL)

Trim	Finish	Wattage	CCT / CRI	Optic	Lens	
MXTG2-RWLR302 (1/2" Regress)	W (White)	L0 (10 Watts)	27 (2700K / 82 CRI)	09 ¹¹ (9° Narrow Spot)	-SL (Solite)	
	B (Black)	L1 (16 Watts)	279 (2700K / 92 CRI)	12 (12° Spot)	-CR (Clear Tempered)	
	SN (Satin Nickel)	L2 (20 Watts)	30 (3000K / 82 CRI)	24 (24° Narrow Flood)	-FR (Frosted)	
	AB (Antique Bronze)	L3 ⁴ (26 Watts)	309 (3000K / 92 CRI)	36 (36° Flood)		
			35 (3500K / 82 CRI)	50 (50° Wide Flood)		
			359 (3500K / 92 CRI)			
			41 (4100K / 82 CRI)			
			419 (4100K / 92 CRI)			

Notes:

- ENERGY STAR® Qualified (White reflectors only; Excludes: L2, L3, 92 CRI & 9° options)
- L0 only; Excludes: 82 CRI & 9° options
- EC1/EC2 not available with (-CP) Chicago Plenum
- L3 available with Non-IC housings only
- Available in 120V only
- Not Available in L3
- Not Available in L2 & L3
- DMX512 RDM not available in L0 & L1
- Access above ceiling required & emergency option not available with Chicago plenum
- Not available in L0
- 9° NS available in 279 with L0 or L1 Only

MX WOOD CEILING L/M-1003.23 P.5

INTENSE LIGHTING | 3340 E La Palma Ave, Anaheim, CA 92806 | tel 714 630-9877 | fax 714 630-9883

For Intense Lighting's limited product warranty, go to www.intenselighting.com. For a printed copy of the warranty, you may call 800 961-5321.

© 2023 Intense Lighting, LLC. All rights reserved. Note: This document is subject to change without notice.



MXG2DRTR

3.5" MX G2 LED Lensed Downlight Wood Ceiling - Wet Location

JOB NAME		CATALOG NUMBER	
NOTES		TYPE	

NON-IC & AIR TIGHT IC DIMENSIONS

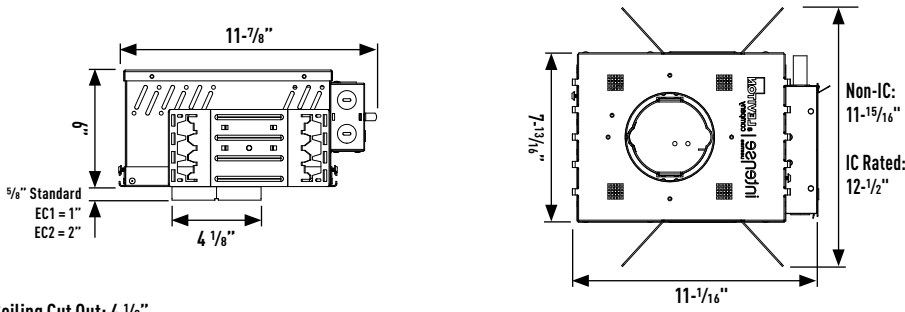

Ceiling Cut Out: 4 1/8"

Plaster Frame Accommodation

Collar Type	Max Ceiling Thickness
Standard	Up-to 5/8"
EC1	Up-to 1"
EC2	Up-to 2"

CCEA CHICAGO PLENUM DIMENSIONS

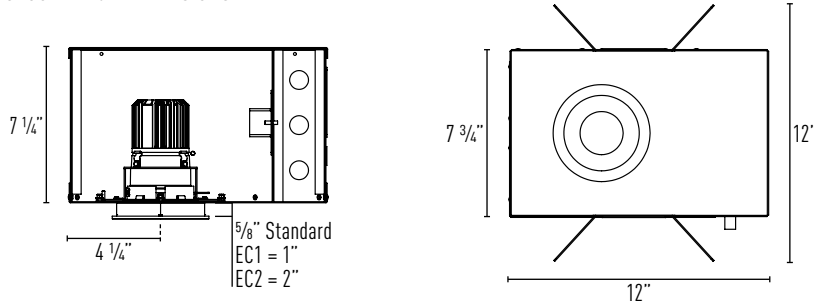

Ceiling Cut Out: 4 1/8"

Plaster Frame Accommodation

Collar Type	Max Ceiling Thickness
Standard	Up-to 5/8"
EC1	Up-to 1"
EC2	Up-to 2"

OPTICS REPLACEMENT

1. Rotate release cap by turning counter clockwise.
2. Install accessories into accessory holder and replace accessory holder's retaining clip.
3. Place accessory holder and accessory flush against optic and replace release cap.

Optics

- IP-OP4712 (12° Spot)
- IP-OP4724 (24° Narrow Flood)
- IP-OP4736 (36° Flood)
- IP-OP4750 (50° Wide Flood)

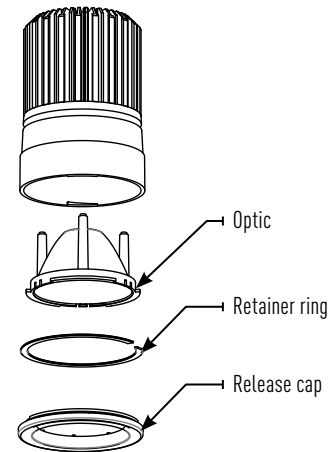

JOB NAME		CATALOG NUMBER	
NOTES		TYPE	

MXTG2-RTRD302WLO-CR

Report #: ILL-01262016-37 (12)
 ILL-01262016-40 (24)
 ILL-01262016-43 (36)
 ILL-01262016-46 (50)

MXTG2-RWLR302

Ceiling Thickness Multipliers:
 5/8" Thickness (x 0.90)
 1" Thickness (x 0.77)
 2" Thickness (x 0.63)

CCT MULTIPLIERS:

	82 CRI	92 CRI
2700K	(x 0.93)	(x 0.76)
3000K	(x 1.00)	(x 0.87)
3500K	(x 1.00)	(x 0.87)
4100K	(x 1.00)	(x 0.87)

LENS MULTIPLIERS:

Solite	(x 0.92)
Clear	(x 1.00)
Frosted	(x 0.92)

EMERGENCY MULTIPLIER:

7W Emergency (x 0.70)

12° Spot (12)

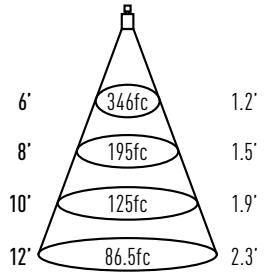

Watts: 10
 Lumens: 717
 LPW: 72
 CCT: 3000K

Candelas at Nadir

Degree	CBCP
0°	12456
5°	6904
15°	519
25°	87
35°	32
45°	5

24° Narrow Flood (24)

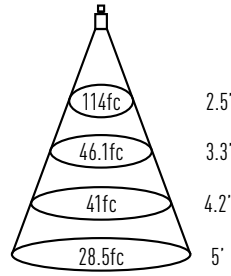

Watts: 10
 Lumens: 794
 LPW: 79
 CCT: 3000K

Candelas at Nadir

Degree	CBCP
0°	4104
5°	3632
15°	1263
25°	207
35°	23
45°	3

36° Flood (36)

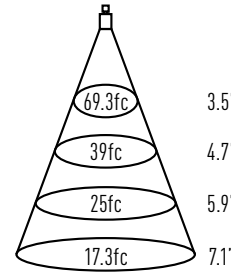

Watts: 10
 Lumens: 879
 LPW: 88
 CCT: 3000K

Candelas at Nadir

Degree	CBCP
0°	2495
5°	2519
15°	1486
25°	412
35°	64
45°	6

50° Wide Flood (50)

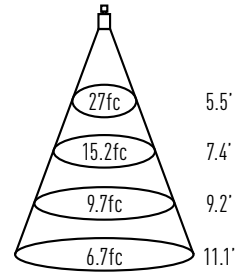

Watts: 10
 Lumens: 770
 LPW: 77
 CCT: 3000K

Candelas at Nadir

Degree	CBCP
0°	970
5°	1026
15°	911
25°	527
35°	204
45°	51

MXTG2-RTRD302WL1-CR

Report #: ILL-01262016-13 (12)
 ILL-01262016-16 (24)
 ILL-01262016-19 (36)
 ILL-01262016-22 (50)

MXTG2-RWLR302

Ceiling Thickness Multipliers:
 5/8" Thickness (x 0.90)
 1" Thickness (x 0.77)
 2" Thickness (x 0.63)

CCT MULTIPLIERS:

	82 CRI	92 CRI
2700K	(x 0.93)	(x 0.76)
3000K	(x 1.00)	(x 0.87)
3500K	(x 1.00)	(x 0.87)
4100K	(x 1.00)	(x 0.87)

LENS MULTIPLIERS:

Solite	(x 0.92)
Clear	(x 1.00)
Frosted	(x 0.92)

EMERGENCY MULTIPLIER:

7W Emergency (x 0.50)
 12W Emergency (x 0.85)

12° Spot (12)

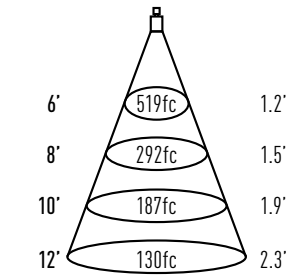

Watts: 15.6
 Lumens: 996
 LPW: 64
 CCT: 3000K

Candelas at Nadir

Degree	CBCP
0°	17192
5°	9571
15°	731
25°	116
35°	44
45°	7

24° Narrow Flood (24)

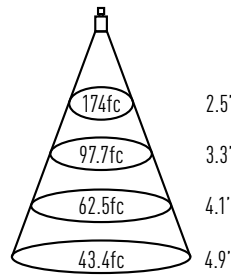

Watts: 15.6
 Lumens: 1103
 LPW: 71
 CCT: 3000K

Candelas at Nadir

Degree	CBCP
0°	5750
5°	5090
15°	1752
25°	291
35°	30
45°	4

36° Flood (36)

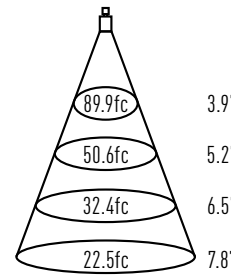

Watts: 15.6
 Lumens: 1221
 LPW: 78
 CCT: 3000K

Candelas at Nadir

Degree	CBCP
0°	2977
5°	2970
15°	1990
25°	651
35°	124
45°	13

50° Wide Flood (50)

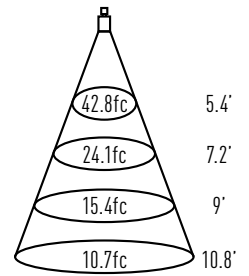

Watts: 15.6
 Lumens: 1078
 LPW: 69
 CCT: 3000K

Candelas at Nadir

Degree	CBCP
0°	1417
5°	1494
15°	1298
25°	726
35°	277
45°	70

JOB NAME		CATALOG NUMBER	
NOTES		TYPE	

MXTG2-RTRD302WL2-CR

Report #: ILL-01262016-25 (12)
 ILL-01262016-28 (24)
 ILL-01262016-31 (36)
 ILL-01262016-34 (50)

MXTG2-RWLR302

Ceiling Thickness Multipliers:
 5/8" Thickness (x 0.90)
 1" Thickness (x 0.77)
 2" Thickness (x 0.63)

CCT MULTIPLIERS:

	82 CRI	92 CRI
2700K	(x 0.93)	(x 0.76)
3000K	(x 1.00)	(x 0.87)
3500K	(x 1.00)	(x 0.87)
4100K	(x 1.00)	(x 0.87)

LENS MULTIPLIERS:

Solite	(x 0.92)
Clear	(x 1.00)
Frosted	(x 0.92)

EMERGENCY MULTIPLIER:

7W Emergency	(x 0.40)
12W Emergency	(x 0.68)

12° Spot (12)

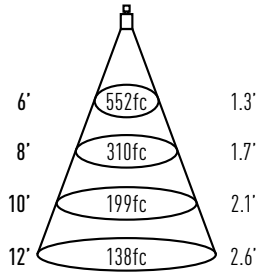

Watts: 20.4
 Lumens: 1246
 LPW: 66
 CCT: 3000K

Candelas at Nadir

Degree	CBCP
0°	19864
5°	12604
15°	733
25°	159
35°	63
45°	10

24° Narrow Flood (24)

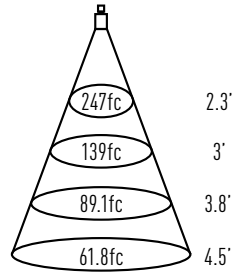

Watts: 20.4
 Lumens: 1411
 LPW: 75
 CCT: 3000K

Candelas at Nadir

Degree	CBCP
0°	8906
5°	7511
15°	2159
25°	253
35°	31
45°	4

36° Flood (36)

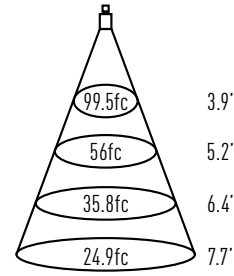

Watts: 20.4
 Lumens: 1433
 LPW: 76
 CCT: 3000K

Candelas at Nadir

Degree	CBCP
0°	3582
5°	3501
15°	2325
25°	762
35°	153
45°	14

50° Wide Flood (50)

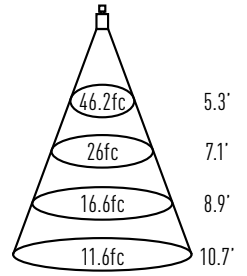

Watts: 20.4
 Lumens: 1245
 LPW: 61
 CCT: 3000K

Candelas at Nadir

Degree	CBCP
0°	1664
5°	1742
15°	1502
25°	835
35°	319
45°	81

MXTG2-RTRD302WL3-CR

Report #: ILL-01262016-10 (12)
 ILL-01262016-07 (24)
 ILL-01262016-01 (36)
 ILL-01062016-04 (50)

MXTG2-RWLR302

Ceiling Thickness Multipliers:
 5/8" Thickness (x 0.90)
 1" Thickness (x 0.77)
 2" Thickness (x 0.63)

CCT MULTIPLIERS:

	82 CRI	92 CRI
2700K	(x 0.93)	(x 0.76)
3000K	(x 1.00)	(x 0.87)
3500K	(x 1.00)	(x 0.87)
4100K	(x 1.00)	(x 0.87)

LENS MULTIPLIERS:

Solite	(x 0.92)
Clear	(x 1.00)
Frosted	(x 0.92)

EMERGENCY MULTIPLIER:

7W Emergency	(x 0.35)
12W Emergency	(x 0.59)

12° Spot (12)

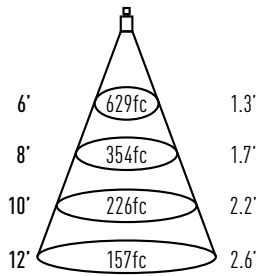

Watts: 26.3
 Lumens: 1446
 LPW: 55
 CCT: 3000K

Candelas at Nadir

Degree	CBCP
0°	22627
5°	14524
15°	824
25°	180
35°	67
45°	12

24° Narrow Flood (24)

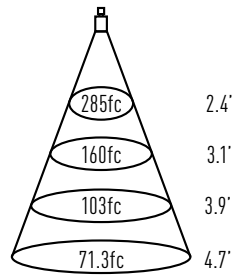

Watts: 26.3
 Lumens: 1726
 LPW: 66
 CCT: 3000K

Candelas at Nadir

Degree	CBCP
0°	11154
5°	9641
15°	2938
25°	345
35°	40
45°	6

36° Flood (36)

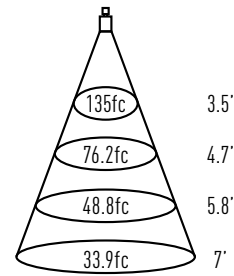

Watts: 26.4
 Lumens: 1664
 LPW: 63
 CCT: 3000K

Candelas at Nadir

Degree	CBCP
0°	4878
5°	4800
15°	2783
25°	756
35°	131
45°	13

50° Wide Flood (50)

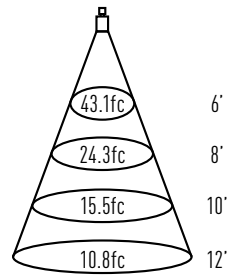

Watts: 26.3
 Lumens: 1340
 LPW: 51
 CCT: 3000K

Candelas at Nadir

Degree	CBCP
0°	1553
5°	1581
15°	1461
25°	919
35°	390
45°	112