

MXG2DRTR

3.5" MX G2 LED Pinhole Wood Ceiling

JOB NAME		CATALOG NUMBER	
NOTES		TYPE	

ELECTRICAL DATA

LED LIGHT ENGINE	System Wattage *	CCT / CRI	Delivered Lumens **	Lumens Per Watt
L0	10W	3000K / 82 CRI	780lm	78
L1	16W	3000K / 82 CRI	1100lm	69
L2	20W	3000K / 82 CRI	1300lm	65
L3	26W	3000K / 82 CRI	1500lm	58

*System Wattage include driver and LED Module consumption. **Delivered lumens will vary depending on trim, CCT, CRI, optic and ceiling thickness

FEATURES

- Multiple architectural trim options
- High center beam spot up to 20,900 CBCP
- Dedicated 9° with field changeable 12°, 24°, 36° & 50° optics

LED LIGHT ENGINE

- 92 CRI & 82 CRI in 2700K, 3000K, 3500K or 4100K with ZSDCM binning
- >50,000 hours L70 (rated life at 70% output)

ELECTRICAL SYSTEM

- (Non-IC) Dedicated voltage options of 120V or 277V. Must be specified in catalog code.
- (-IC/-CP) Universal 120V/277V input
- This product complies with IEEE C62.41 for surge endurance up to 2.5KV. Additional surge protection recommended. Damage from power surge is not covered by warranty.

DIMMING

- 0-10V Dimming 1%
- Forward/reverse dimming 1% (120V only)
- EldoLED 0-10V 0.1% or 1%
- Lutron® LDE1 Hi-Lume 1% EcoSystem LED driver with Soft-on, Fade-to-Black dimming technology
- DMX512 RDM 0.1%

HOUSING

- Heavy duty black powder coated 18 gauge steel frame
- Standard housing accommodates 5/8" ceiling thickness
- Extended collar options available for ceilings up to 1" or 2" thick, must specify either EC1 or EC2 (EC1/EC2 Not available with Chicago Plenum)

TRIM SPECIFICATION

High quality trims are die-cast using A380 aluminum and finished with durable powder coat available in multiple finishes, black interior standard.

INSTALLATION

Housing types include IC Air-Tight, CCEA (Chicago Plenum), or Non-IC Rated (must specify). Non-IC rated housings must be kept at a minimum of 3" away from insulation. Butterfly brackets are compatible with C-channel, adjustable bar hangers (14"-25") and EMT. C-channel is recommended for T-bar ceilings. Bar hangers must be ordered separately. Max. ambient temperature: 95°F (35°C).

EMERGENCY BACKUP

Remote test switch included. External battery operates LED load at a minimum of 400 to 650 lumens for 90 minutes, depending on backup wattage selected. See trim multipliers for detailed performance. Servicing requires above ceiling access. (EM not available with Chicago Plenum)

LISTING / WARRANTY

- 5-Year Intense LED Limited Warranty
- ETL listed to US and Canadian standards for wet locations
- (-IC/-CP Only) Air-Tight Certified ASTM E283
- (-IC/-CP Only) ETL listed for direct contact w/insulation
- (-CP Only) CCEA Chicago Plenum
- ENERGY STAR® Qualified¹
- Can be used to comply with 2016 Title 24, Part 6, JA8 high efficacy LED light source requirements²

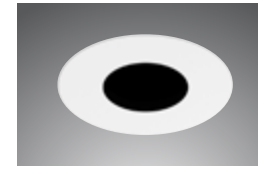

MXTG2-RWLR306
(1/2" Regress with Lens)

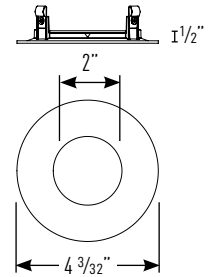

Recommended 4 1/8" precision routing fitment of wood trim; using a hole saw may result in improper fitment, uneven gaps and/or light leak

Housing dimensions are on Page 2

Available Trim Finishes



Housing Part Number (Example: MXG2DRTR-ICL1)

Housing	Installation Type	Ceiling Thickness	Wattage	Dimming	Voltage	Options
MXG2DRTR	-NC (Non-IC)	blank (5/8")	L0 (10 Watts)	blank (Non-Dimming)	blank (Non-IC: 120V -IC/-CP: 120V/277V) 27 (277V Non-IC Only, for -IC/-CP housing options use blank)	I100 (C-Channel Bar Hangers)
	-IC (Air-Tight IC)	EC1 ³ (1")	L1 (16 Watts)	DELV ⁵ (Phase Dimming)		I200 (Flat Bar Hangers)
	-CP (Chicago Plenum)	EC2 ³ (2")	L2 (20 Watts)	D101 (0-10V Dimming 1%)		I400 (Wood Joist Bar Hangers)
			L3 ⁴ (26 Watts)	ED10V1 ⁶ (eldoLED 0-10V 1%) ED10V01 ⁶ (eldoLED 0-10V 0.1%) LUT ⁷ (Lutron® LDE1 EcoSystem 1%) DMXR ⁸ (DMX512 RDM 0.1%)		-EM7 ⁹ (7W Emergency Backup IOTA Part #ILB-CP07-A) -EM12 ^{9,10} (12W Emergency Backup IOTA Part #ILB-CP12-A)

Trim Part Number (Example: MXTG2-RWLR306WL13024)

Trim	Finish	Wattage	CCT / CRI	Optic
MXTG2-RWLR306 (1/2" Regress)	W (White)	L0 (10 Watts)	27 (2700K / 82 CRI)	09 ¹¹ (9° Narrow Spot)
	B (Black)	L1 (16 Watts)	279 (2700K / 92 CRI)	12 (12° Spot)
	SN (Satin Nickel)	L2 (20 Watts)	30 (3000K / 82 CRI)	24 (24° Narrow Flood)
	AB (Antique Bronze)	L3 ⁴ (26 Watts)	309 (3000K / 92 CRI)	36 (36° Flood)
		35 (3500K / 82 CRI)	50 (50° Wide Flood)	
		359 (3500K / 92 CRI)		
		41 (4100K / 82 CRI)		
		419 (4100K / 92 CRI)		

Notes:

- ENERGY STAR® Qualified (White reflectors only; Excludes: L2, L3, 92 CRI & 9° options)
- L0 only; Excludes: 82 CRI & 9° options
- EC1/EC2 not available with (-CP) Chicago Plenum
- L3 available with Non-IC housings only
- Available in 120V only
- Not Available in L3
- Not Available in L2 & L3
- DMX512 RDM not available in L0 & L1
- Access above ceiling required & emergency option not available with Chicago plenum
- Not available in L0
- 9° NS available in 279 with L0 or L1 Only

MX WOOD CEILING L/M-1003.23 P-9

INTENSE LIGHTING | 3340 E La Palma Ave, Anaheim, CA 92806 | tel 714 630-9877 | fax 714 630-9883

For Intense Lighting's limited product warranty, go to www.intenselighting.com. For a printed copy of the warranty, you may call 800 961-5321.

© 2023 Intense Lighting, LLC. All rights reserved. Note: This document is subject to change without notice.



MXG2DRTR

3.5" MX G2 LED Pinhole Wood Ceiling

JOB NAME		CATALOG NUMBER	
NOTES		TYPE	

NON-IC & AIR TIGHT IC DIMENSIONS

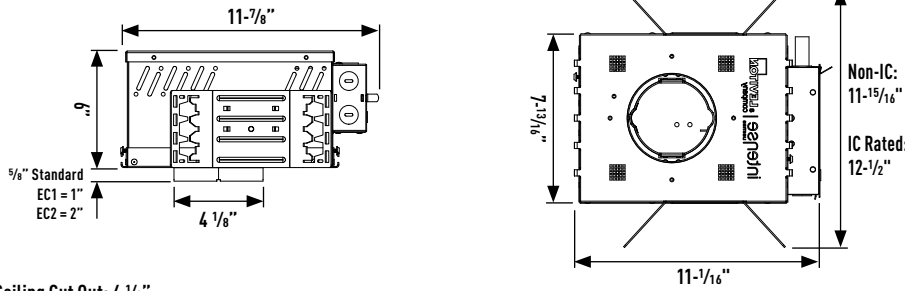

Ceiling Cut Out: 4 1/8"

Plaster Frame Accommodation

Collar Type	Max Ceiling Thickness
Standard	Up-to 5/8"
EC1	Up-to 1"
EC2	Up-to 2"

CCEA CHICAGO PLENUM DIMENSIONS

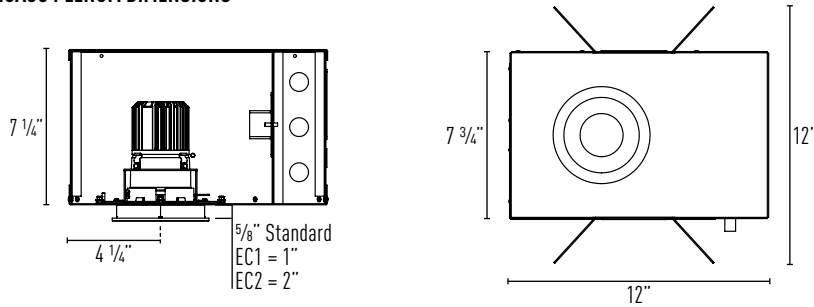

Ceiling Cut Out: 4 1/8"

Plaster Frame Accommodation

Collar Type	Max Ceiling Thickness
Standard	Up-to 5/8"
EC1	Up-to 1"
EC2	Up-to 2"

ACCESSORIES

Luminaire will accommodate (2) accessories, accessory holder required.

INSTALLATION

1. Rotate release cap by turning counter clockwise.
2. Install accessories into accessory holder and replace accessory holder's retaining clip.
3. Place accessory holder and accessory flush against optic and replace release cap.

Accessories

LH47	(Accessory Holder, Black)
LH47W	(Accessory Holder, White)
PFLMB-47	(Hex Louver, Black)
PFL1-47	(Prismatic Spread Lens)
PFL2-47	(Linear Spread Lens)
PFL4-47	(Soft Focus Lens)

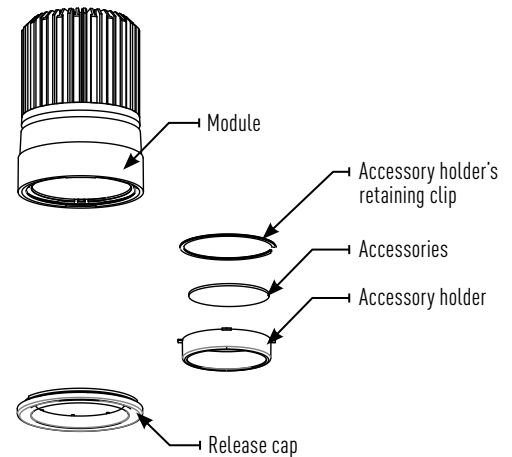

OPTICS REPLACEMENT

1. Rotate release cap by turning counter clockwise.
2. Install accessories into accessory holder and replace accessory holder's retaining clip.
3. Place accessory holder and accessory flush against optic and replace release cap.

Optics

IP-OP4712	(12° Spot)
IP-OP4724	(24° Narrow Flood)
IP-OP4736	(36° Flood)
IP-OP4750	(50° Wide Flood)

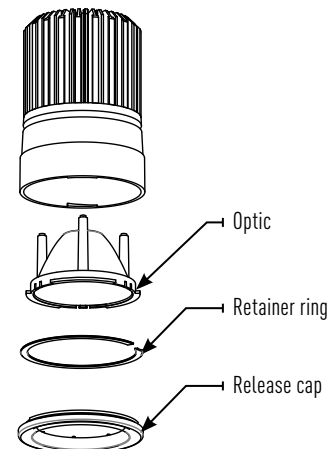

MX WOOD CEILING L/M-1003.23 P-10

INTENSE LIGHTING | 3340 E La Palma Ave, Anaheim, CA 92806 | tel 714 630-9877 | fax 714 630-9883

For Intense Lighting's limited product warranty, go to www.intenselighting.com. For a printed copy of the warranty, you may call 800 961-5321.

© 2023 Intense Lighting, LLC. All rights reserved. Note: This document is subject to change without notice.

JOB NAME		CATALOG NUMBER	
NOTES		TYPE	

MXTG2-RTRD306L0

Report #: ILL-01262016-38 (12)
 ILL-02082016-11 (24)
 ILL-01262016-44 (36)
 ILL-01262016-47 (50)

MXTG2-RWLR306

Ceiling Thickness Multipliers:
 5/8" Thickness (x 0.98)
 1" Thickness (x 0.80)
 2" Thickness (x 0.65)

CCT MULTIPLIERS:

	82 CRI	92 CRI
2700K	(x 0.93)	(x 0.76)
3000K	(x 1.00)	(x 0.87)
3500K	(x 1.00)	(x 0.87)
4100K	(x 1.00)	(x 0.87)

EMERGENCY MULTIPLIER:

7W Emergency (x 0.70)

12° Spot (12)

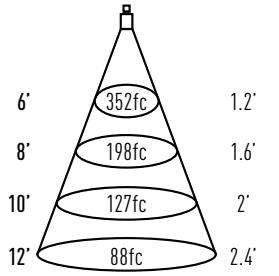

Watts: 10
 Lumens: 725
 LPW: 73
 CCT: 3000K

Candelas at Nadir

Degree	CBCP
0°	12674
5°	7407
15°	524
25°	50
35°	9
45°	3

24° Narrow Flood (24)

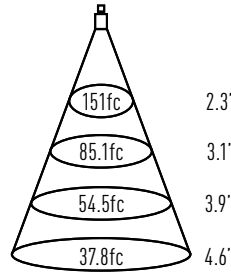

Watts: 10
 Lumens: 835
 LPW: 83
 CCT: 3000K

Candelas at Nadir

Degree	CBCP
0°	5449
5°	4890
15°	1255
25°	93
35°	8
45°	3

36° Flood (36)

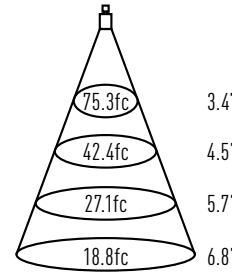

Watts: 10
 Lumens: 848
 LPW: 85
 CCT: 3000K

Candelas at Nadir

Degree	CBCP
0°	2712
5°	2745
15°	1555
25°	314
35°	31
45°	3

50° Wide Flood (50)

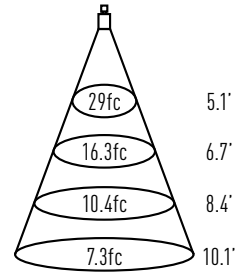

Watts: 10
 Lumens: 676
 LPW: 68
 CCT: 3000K

Candelas at Nadir

Degree	CBCP
0°	1043
5°	1102
15°	969
25°	469
35°	124
45°	7

MXTG2-RTRD306L1

Report #: ILL-01262016-14 (12)
 ILL-02082016-09 (24)
 ILL-01262016-20 (36)
 ILL-01262016-23 (50)

MXTG2-RWLR306

Ceiling Thickness Multipliers:
 5/8" Thickness (x 0.98)
 1" Thickness (x 0.80)
 2" Thickness (x 0.65)

CCT MULTIPLIERS:

	82 CRI	92 CRI
2700K	(x 0.93)	(x 0.76)
3000K	(x 1.00)	(x 0.87)
3500K	(x 1.00)	(x 0.87)
4100K	(x 1.00)	(x 0.87)

EMERGENCY MULTIPLIER:

7W Emergency (x 0.50)
 12W Emergency (x 0.85)

12° Spot (12)

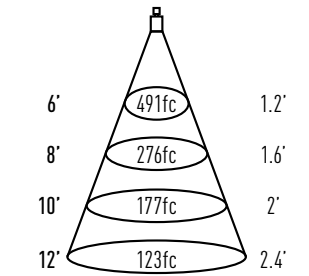

Watts: 15.6
 Lumens: 996
 LPW: 64
 CCT: 3000K

Candelas at Nadir

Degree	CBCP
0°	17685
5°	10155
15°	718
25°	69
35°	13
45°	4

24° Narrow Flood (24)

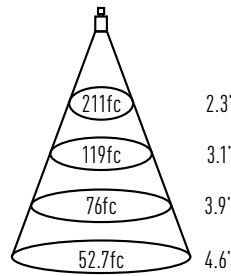

Watts: 15.6
 Lumens: 1165
 LPW: 75
 CCT: 3000K

Candelas at Nadir

Degree	CBCP
0°	7595
5°	6824
15°	1751
25°	129
35°	11
45°	4

36° Flood (36)

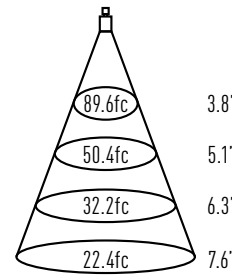

Watts: 15.6
 Lumens: 1204
 LPW: 77
 CCT: 3000K

Candelas at Nadir

Degree	CBCP
0°	3225
5°	3213
15°	2123
25°	569
35°	80
45°	3

50° Wide Flood (50)

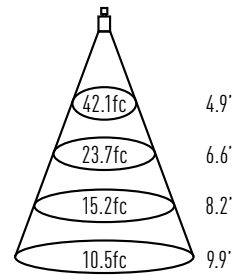

Watts: 15.6
 Lumens: 945
 LPW: 61
 CCT: 3000K

Candelas at Nadir

Degree	CBCP
0°	1517
5°	1599
15°	1376
25°	645
35°	166
45°	10

JOB NAME		CATALOG NUMBER	
NOTES		TYPE	

MXTG2-RTRD306L2

Report #: ILL-01262016-26 (12)
 ILL-02082016-06 (24)
 ILL-01262016-32 (36)
 ILL-02082016-05 (50)

MXTG2-RWLR306

Ceiling Thickness Multipliers:
 5/8" Thickness (x 0.98)
 1" Thickness (x 0.80)
 2" Thickness (x 0.65)

CCT MULTIPLIERS:

	82 CRI	92 CRI
2700K	(x 0.93)	(x 0.76)
3000K	(x 1.00)	(x 0.87)
3500K	(x 1.00)	(x 0.87)
4100K	(x 1.00)	(x 0.87)

EMERGENCY MULTIPLIER:

7W Emergency	(x 0.40)
12W Emergency	(x 0.68)

12° Spot (12)

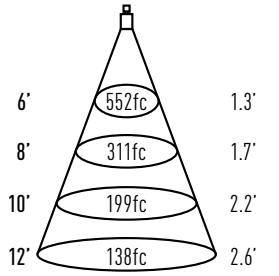

Watts: 20.4
 Lumens: 1225
 LPW: 60
 CCT: 3000K

Candelas at Nadir

Degree	CBCP
0°	19887
5°	12965
15°	776
25°	98
35°	17
45°	4

24° Narrow Flood (24)

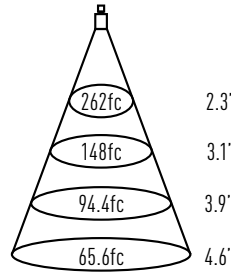

Watts: 20.8
 Lumens: 1425
 LPW: 69
 CCT: 3000K

Candelas at Nadir

Degree	CBCP
0°	9443
5°	8622
15°	2133
25°	133
35°	14
45°	5

36° Flood (36)

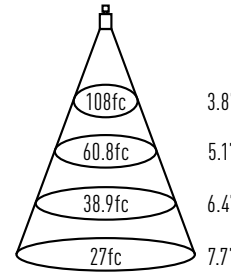

Watts: 20.4
 Lumens: 1450
 LPW: 71
 CCT: 3000K

Candelas at Nadir

Degree	CBCP
0°	3888
5°	3833
15°	2558
25°	680
35°	100
45°	4

50° Wide Flood (50)

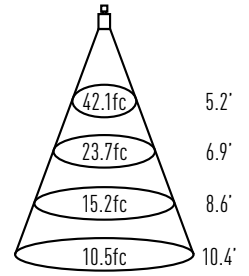

Watts: 20.8
 Lumens: 1153
 LPW: 55
 CCT: 3000K

Candelas at Nadir

Degree	CBCP
0°	1516
5°	1602
15°	1553
25°	844
35°	257
45°	17

MXTG2-RTRD306L3

Report #: ILL-01262016-11 (12)
 ILL-02082016-02 (24)
 ILL-01262016-02 (36)
 ILL-02082016-01 (50)

MXTG2-RWLR306

Ceiling Thickness Multipliers:
 5/8" Thickness (x 0.98)
 1" Thickness (x 0.80)
 2" Thickness (x 0.65)

CCT MULTIPLIERS:

	82 CRI	92 CRI
2700K	(x 0.93)	(x 0.76)
3000K	(x 1.00)	(x 0.87)
3500K	(x 1.00)	(x 0.87)
4100K	(x 1.00)	(x 0.87)

EMERGENCY MULTIPLIER:

7W Emergency	(x 0.35)
12W Emergency	(x 0.59)

12° Spot (12)

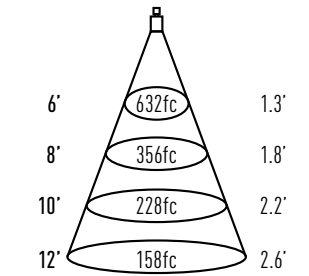

Watts: 26.3
 Lumens: 1413
 LPW: 54
 CCT: 3000K

Candelas at Nadir

Degree	CBCP
0°	22755
5°	14920
15°	840
25°	103
35°	21
45°	5

24° Narrow Flood (24)

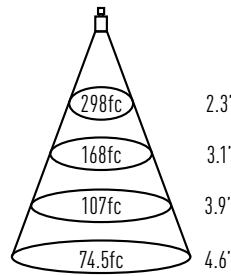

Watts: 26.3
 Lumens: 1621
 LPW: 62
 CCT: 3000K

Candelas at Nadir

Degree	CBCP
0°	10730
5°	9793
15°	2426
25°	152
35°	16
45°	6

36° Flood (36)

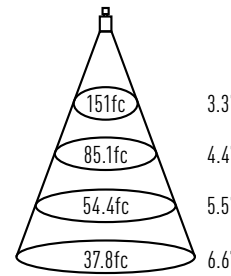

Watts: 26.4
 Lumens: 1627
 LPW: 62
 CCT: 3000K

Candelas at Nadir

Degree	CBCP
0°	5444
5°	5349
15°	2905
25°	593
35°	79
45°	6

50° Wide Flood (50)

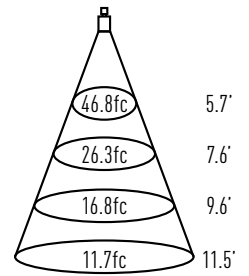

Watts: 26.3
 Lumens: 1203
 LPW: 46
 CCT: 3000K

Candelas at Nadir

Degree	CBCP
0°	1683
5°	1639
15°	1485
25°	880
35°	322
45°	28