

MXG2DSTR

3.5" MX G2 LED Square Pinhole Wood Ceiling

JOB NAME		CATALOG NUMBER	
NOTES		TYPE	

ELECTRICAL DATA

LED LIGHT ENGINE	System Wattage *	CCT / CRI	Delivered Lumens **	Lumens Per Watt
L0	10W	3000K / 82 CRI	700lm	70
L1	16W	3000K / 82 CRI	1000lm	63
L2	20W	3000K / 82 CRI	1150lm	58
L3	26W	3000K / 82 CRI	1600lm	62

*System Wattage include driver and LED Module consumption. **Delivered lumens will vary depending on trim, CCT, CRI, optic and ceiling thickness

FEATURES

- Multiple architectural trim options
- High center beam spot up to 21,700 CBCP
- Dedicated 9° with field changeable 12°, 24°, 36° & 50° optics

LED LIGHT ENGINE

- 92 CRI & 82 CRI in 2700K, 3000K, 3500K or 4100K with 2SDCM binning
- >50,000 hours L70 (rated life at 70% output)

ELECTRICAL SYSTEM

- (Non-IC) Dedicated voltage options of 120V or 277V. Must be specified in catalog code.
- (-IC) Universal 120V/277V input
- This product complies with IEEE C62.41 for surge endurance up to 2.5KV. Additional surge protection recommended. Damage from power surge is not covered by warranty.

DIMMING

- 0-10V Dimming 1%
- Forward/reverse dimming 1% (120V only)
- EldoLED 0-10V 0.1% or 1%
- Lutron® LDE1 Hi-Lume 1% EcoSystem LED driver with Soft-on, Fade-to-Black dimming technology
- DMX512 RDM 0.1%

HOUSING

- Heavy duty black powder coated 18 gauge steel frame
- Standard housing accommodates 5/8" ceiling thickness
- Extended collar options available for ceilings up to 1" or 2" thick, must specify either EC1 or EC2

TRIM SPECIFICATION

High quality trims are die-cast using A380 aluminum and finished with durable powder coat available in multiple finishes, black interior standard.

INSTALLATION

Housing types include IC Air-Tight or Non-IC Rated (must specify). Non-IC rated housings must be kept at a minimum of 3" away from insulation. Butterfly brackets are compatible with C-channel, adjustable bar hangers (14"-25") and EMT. C-channel is recommended for T-bar ceilings. Bar hangers must be ordered separately. Max. ambient temperature: 95°F (35°C).

EMERGENCY BACKUP

Remote test switch included. External battery operates LED load at a minimum of 400 to 650 lumens for 90 minutes, depending on backup wattage selected. See trim multipliers for detailed performance. Servicing requires above ceiling access.

Accessories

Luminaire will accommodate (2) accessories, accessory holder required, see page 2.

Listing / warranty

- 5-Year Intense LED Limited Warranty
- ETL listed to US and Canadian standards for damp locations
- (-IC Only) Air-Tight Certified ASTM E283
- (-IC Only) ETL listed for direct contact w/insulation
- ENERGY STAR® Qualified ¹
- Can be used to comply with 2016 Title 24, Part 6, JA8 high efficacy LED light source requirements ²

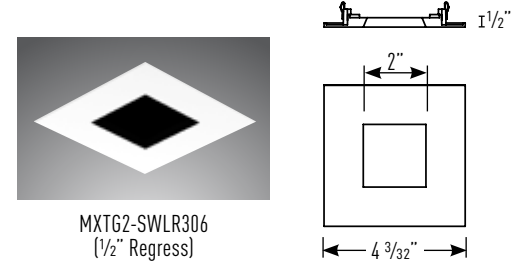

MXTG2-SWLR306
(1/2" Regress)

Recommended 4 1/8" precision routing fitment of wood trim; using a hole saw may result in improper fitment, uneven gaps and/or light leak

Housing dimensions are on Page 2

Available Trim Finishes



Housing Part Number (Example: MXG2DSTR-ICL1)

Housing	Installation Type	Ceiling Thickness	Wattage	Dimming	Voltage	Options
MXG2DSTR	-NC (Non-IC)	blank (5/8")	L0 (10 Watts)	blank (Non-Dimming)	blank (Non-IC: 120V	I100 (C-Channel Bar Hangers) I200 (Flat Bar Hangers) I400 (Wood Joist Bar Hangers) -EM7⁸ (7W Emergency Backup IOTA Part #ILB-CP07-A) -EM12^{8,9} (12W Emergency Backup IOTA Part #ILB-CP12-A)
	-IC (Air-Tight IC)	EC1 (1")	L1 (16 Watts)	DELV ⁴ (Phase Dimming)	-IC/-CP: 120V/277V)	
		EC2 (2")	L2 (20 Watts)	D101 (0-10V Dimming 1%)	27 (277V Non-IC Only, for	
			L3 ³ (26 Watts)	ED10V1 ⁵ (elddoLED 0-10V 1%)	-IC/-CP housing options use blank)	
			L3 ³ (26 Watts)	ED10V01 ⁵ (elddoLED 0-10V 0.1%)		
				LUT ⁶ (Lutron® LDE1 EcoSystem 1%)		
				DMXR ⁷ (DMX512 RDM 0.1%)		

Trim Part Number (Example: MXTG2-SWLR306WL13024)

Trim	Finish	Wattage	CCT / CRI	Optic
MXTG2-SWLR306 (1/2" Regress)	W (White)	L0 (10 Watts)	27 (2700K / 82 CRI)	09 ¹⁰ (9° Narrow Spot)
	B (Black)	L1 (16 Watts)	279 (2700K / 92 CRI)	12 (12° Spot)
	SN (Satin Nickel)	L2 (20 Watts)	30 (3000K / 82 CRI)	24 (24° Narrow Flood)
	AB (Antique Bronze)	L3 ³ (26 Watts)	309 (3000K / 92 CRI)	36 (36° Flood)
			35 (3500K / 82 CRI)	50 (50° Wide Flood)
			359 (3500K / 92 CRI)	
			41 (4100K / 82 CRI)	
			419 (4100K / 92 CRI)	

Notes:

- ENERGY STAR® Qualified (White reflectors only). Excludes: L2, L3, 92 CRI & 9° options
- L0 only; Excludes: 82 CRI & 9° options
- L3 available with Non-IC housings only
- Available in 120V only
- Not Available in L3
- Not Available in L2 & L3
- DMX512 RDM not available in L0 & L1
- Access above ceiling required
- Not available in L0
- 9° NS available in 279 with L0 or L1 Only

MX WOOD CEILING L/M-1003.23 P-25

INTENSE LIGHTING | 3340 E La Palma Ave, Anaheim, CA 92806 | tel 714 630-9877 | fax 714 630-9883

For Intense Lighting's limited product warranty, go to www.intenselighting.com. For a printed copy of the warranty, you may call 800 961-5321.

© 2023 Intense Lighting, LLC. All rights reserved. Note: This document is subject to change without notice.



MXG2DSTR

3.5" MX G2 LED Square Pinhole Wood Ceiling

JOB NAME		CATALOG NUMBER	
NOTES		TYPE	

NON-IC & AIR TIGHT IC DIMENSIONS

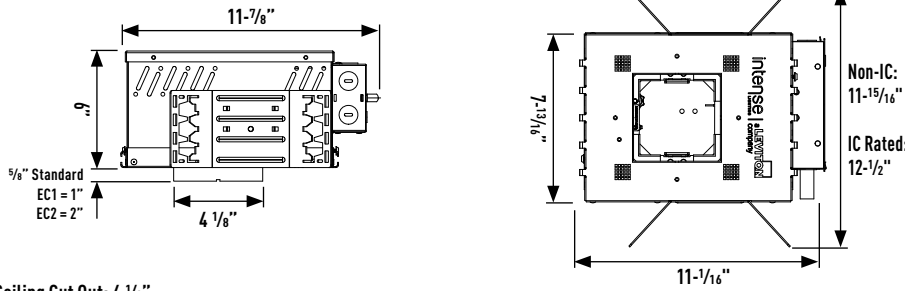

Ceiling Cut Out: 4 1/8"

Plaster Frame Accommodation

Collar Type	Max Ceiling Thickness
Standard	Up-to 5/8"
EC1	Up-to 1"
EC2	Up-to 2"

CCEA CHICAGO PLENUM DIMENSIONS

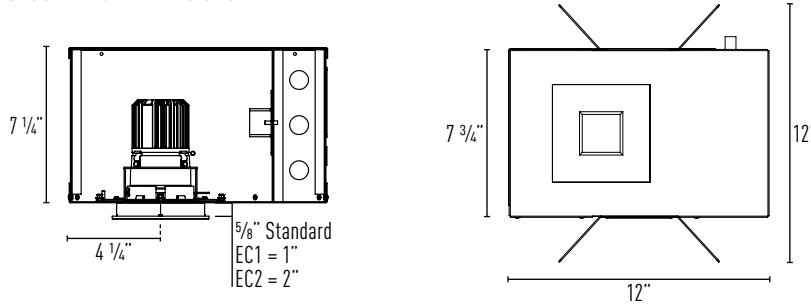

Ceiling Cut Out: 4 1/8"

Plaster Frame Accommodation

Collar Type	Max Ceiling Thickness
Standard	Up-to 5/8"
EC1	Up-to 1"
EC2	Up-to 2"

ACCESSORIES:

Luminaire will accommodate (2) accessories, accessory holder required.

INSTALLATION:

1. Rotate release cap by turning counter clockwise.
2. Install accessories into accessory holder and replace accessory holder's retaining clip.
3. Place accessory holder and accessory flush against optic and replace release cap.

Accessories

LH47	(Accessory Holder, Black)
LH47W	(Accessory Holder, White)
PFLMB-47	(Hex Louver, Black)
PFL1-47	(Prismatic Spread Lens)
PFL2-47	(Linear Spread Lens)
PFL4-47	(Soft Focus Lens)

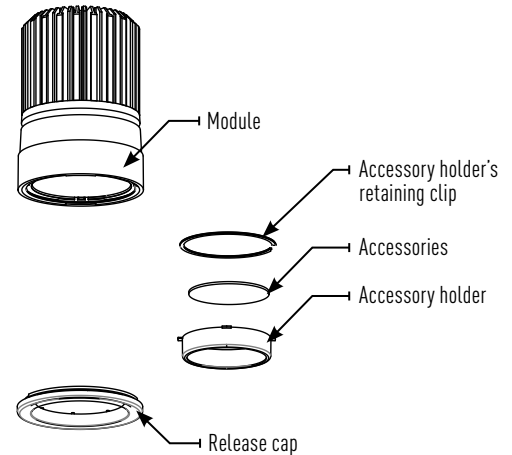

OPTICS REPLACEMENT

1. Rotate release cap by turning counter clockwise.
2. Install accessories into accessory holder and replace accessory holder's retaining clip.
3. Place accessory holder and accessory flush against optic and replace release cap.

Optics

IP-OP4712	(12° Spot)
IP-OP4724	(24° Narrow Flood)
IP-OP4736	(36° Flood)
IP-OP4750	(50° Wide Flood)

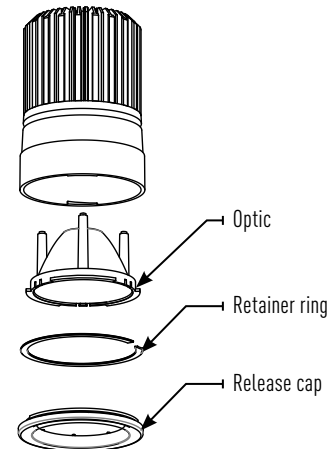

JOB NAME		CATALOG NUMBER	
NOTES		TYPE	

MXTG2-STRD306L0

Report #: ILL-02122016-11.3 (12)
 ILL-02122016-10.3 (24)
 ILL-02162016-02.3 (36)
 ILL-02122016-06.3 (50)

MXTG2-SWLR306

Ceiling Thickness Multipliers:
 5/8" Thickness (x 1.00)
 1" Thickness (x 0.83)
 2" Thickness (x 0.56)

CCT MULTIPLIERS:

	82 CRI	92 CRI
2700K	(x 0.93)	(x 0.76)
3000K	(x 1.00)	(x 0.87)
3500K	(x 1.00)	(x 0.87)
4100K	(x 1.00)	(x 0.87)

EMERGENCY MULTIPLIER:

7W Emergency (x 0.70)

12° Spot (12)

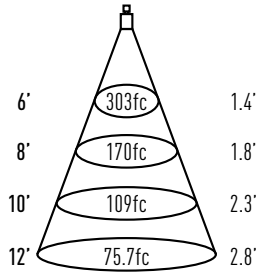

Footcandles at Nadir

Watts: 10
 Lumens: 582
 LPW: 58
 CCT: 3000K

Candelas at Nadir

Degree	CBCP
0°	10895
5°	6333
15°	468
25°	43
35°	9
45°	2

24° Narrow Flood (24)

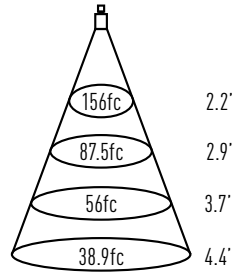

Watts: 10
 Lumens: 715
 LPW: 72
 CCT: 3000K

Candelas at Nadir

Degree	CBCP
0°	5600
5°	4829
15°	1002
25°	48
35°	4
45°	1

36° Flood (36)

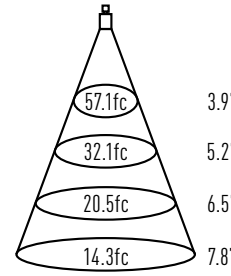

Watts: 10
 Lumens: 689
 LPW: 69
 CCT: 3000K

Candelas at Nadir

Degree	CBCP
0°	2054
5°	2020
15°	1333
25°	380
35°	55
45°	1

50° Wide Flood (50)

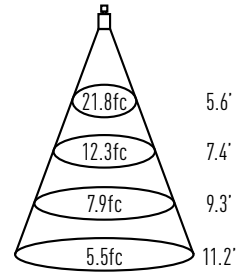

Watts: 10
 Lumens: 577
 LPW: 58
 CCT: 3000K

Candelas at Nadir

Degree	CBCP
0°	785
5°	785
15°	724
25°	383
35°	102
45°	4

MXTG2-STRD306L1

Report #: ILL-02122016-11.2 (12)
 ILL-02122016-10.2 (24)
 ILL-02162016-02.2 (36)
 ILL-02122016-06.2 (50)

MXTG2-SWLR306

Ceiling Thickness Multipliers:
 5/8" Thickness (x 1.00)
 1" Thickness (x 0.83)
 2" Thickness (x 0.56)

CCT MULTIPLIERS:

	82 CRI	92 CRI
2700K	(x 0.93)	(x 0.76)
3000K	(x 1.00)	(x 0.87)
3500K	(x 1.00)	(x 0.87)
4100K	(x 1.00)	(x 0.87)

EMERGENCY MULTIPLIER:

7W Emergency (x 0.50)
 12W Emergency (x 0.85)

12° Spot (12)

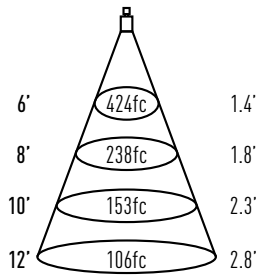

Footcandles at Nadir

Watts: 15.4
 Lumens: 814
 LPW: 53
 CCT: 3000K

Candelas at Nadir

Degree	CBCP
0°	15253
5°	8866
15°	655
25°	60
35°	13
45°	2

24° Narrow Flood (24)

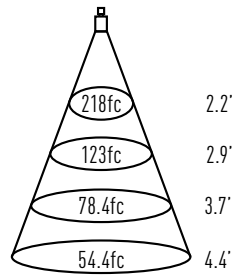

Watts: 15.4
 Lumens: 1001
 LPW: 65
 CCT: 3000K

Candelas at Nadir

Degree	CBCP
0°	7841
5°	6760
15°	1402
25°	67
35°	6
45°	1

36° Flood (36)

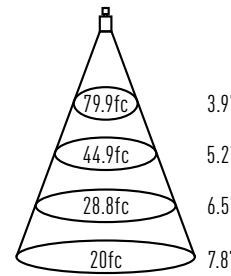

Watts: 15.4
 Lumens: 964
 LPW: 63
 CCT: 3000K

Candelas at Nadir

Degree	CBCP
0°	2876
5°	2828
15°	1867
25°	532
35°	77
45°	1

50° Wide Flood (50)

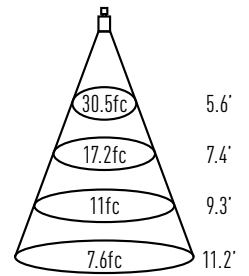

Watts: 15.4
 Lumens: 808
 LPW: 52
 CCT: 3000K

Candelas at Nadir

Degree	CBCP
0°	1099
5°	1099
15°	1013
25°	536
35°	143
45°	5

JOB NAME		CATALOG NUMBER	
NOTES		TYPE	

MXTG2-STRD306L2

Report #: ILL-02122016-11.1 (12)
 ILL-02122016-10.1 (24)
 ILL-02162016-02.1 (36)
 ILL-02122016-06.1 (50)

MXTG2-SWLR306

Ceiling Thickness Multipliers:
 5/8" Thickness (x 1.00)
 1" Thickness (x 0.83)
 2" Thickness (x 0.56)

CCT MULTIPLIERS:

	82 CRI	92 CRI
2700K	(x 0.93)	(x 0.76)
3000K	(x 1.00)	(x 0.87)
3500K	(x 1.00)	(x 0.87)
4100K	(x 1.00)	(x 0.87)

EMERGENCY MULTIPLIER:

7W Emergency (x 0.40)
 12W Emergency (x 0.68)

12° Spot (12)

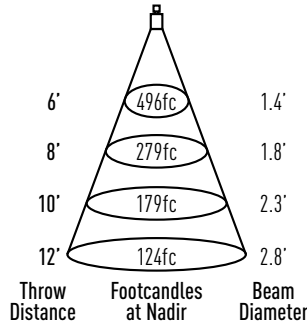

Watts: 20.5
 Lumens: 954
 LPW: 47
 CCT: 3000K

Candelas at Nadir

Degree	CBCP
0°	17868
5°	10385
15°	768
25°	70
35°	15
45°	3

24° Narrow Flood (24)

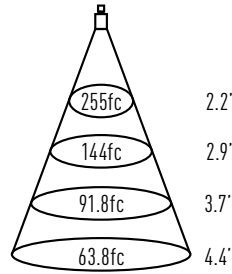

Watts: 20.4
 Lumens: 1173
 LPW: 57
 CCT: 3000K

Candelas at Nadir

Degree	CBCP
0°	9185
5°	7919
15°	1642
25°	79
35°	7
45°	1

36° Flood (36)

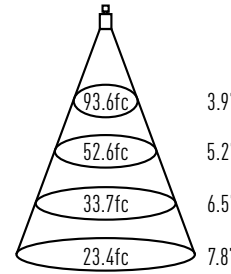

Watts: 20.5
 Lumens: 1129
 LPW: 55
 CCT: 3000K

Candelas at Nadir

Degree	CBCP
0°	3369
5°	3313
15°	2187
25°	623
35°	90
45°	1

50° Wide Flood (50)

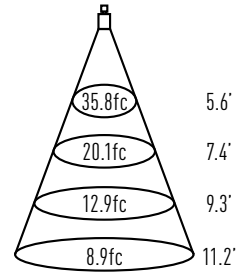

Watts: 20.5
 Lumens: 946
 LPW: 46
 CCT: 3000K

Candelas at Nadir

Degree	CBCP
0°	1287
5°	1287
15°	1187
25°	628
35°	168
45°	6

MXTG2-STRD306L3

Report #: ILL-02122016-11 (12)
 ILL-02122016-10 (24)
 ILL-02162016-02 (36)
 ILL-02122016-06 (50)

MXTG2-SWLR306

Ceiling Thickness Multipliers:
 5/8" Thickness (x 1.00)
 1" Thickness (x 0.83)
 2" Thickness (x 0.56)

CCT MULTIPLIERS:

	82 CRI	92 CRI
2700K	(x 0.93)	(x 0.76)
3000K	(x 1.00)	(x 0.87)
3500K	(x 1.00)	(x 0.87)
4100K	(x 1.00)	(x 0.87)

EMERGENCY MULTIPLIER:

7W Emergency (x 0.35)
 12W Emergency (x 0.59)

12° Spot (12)

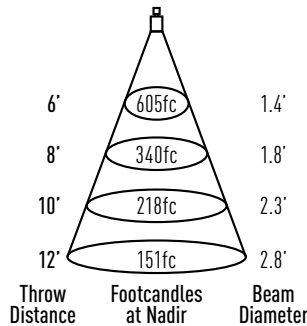

Watts: 26.1
 Lumens: 1163
 LPW: 45
 CCT: 3000K

Candelas at Nadir

Degree	CBCP
0°	21791
5°	12665
15°	936
25°	86
35°	19
45°	3

24° Narrow Flood (24)

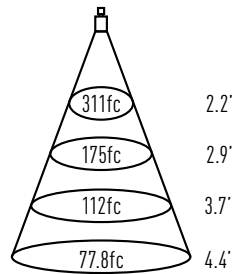

Watts: 26.1
 Lumens: 1430
 LPW: 55
 CCT: 3000K

Candelas at Nadir

Degree	CBCP
0°	11201
5°	9657
15°	2003
25°	96
35°	9
45°	1

36° Flood (36)

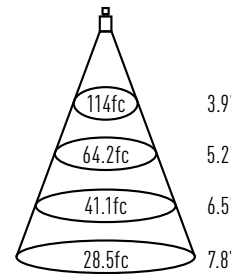

Watts: 26
 Lumens: 1377
 LPW: 53
 CCT: 3000K

Candelas at Nadir

Degree	CBCP
0°	4109
5°	4040
15°	2667
25°	760
35°	109
45°	2

50° Wide Flood (50)

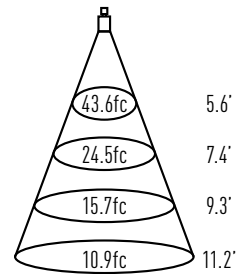

Watts: 26.1
 Lumens: 1154
 LPW: 44
 CCT: 3000K

Candelas at Nadir

Degree	CBCP
0°	1570
5°	1570
15°	1447
25°	765
35°	205
45°	7